

**SOKKIA**

**GRX3**

**GNSS Receiver**

Operator Manual



**GRX3**  
**GNSS Receiver**  
**Operator Manual**

Part Number 1030371-01

Revision C

©2022, Sokkia

# Table of Contents

<b>Preface</b> .....	<b>iv</b>
<b>Introduction</b> .....	<b>1-1</b>
<b>GRX3 Features</b> .....	<b>1-2</b>
<b>Unpacking Your Receiver Kit</b> .....	<b>1-3</b>
Standard Kit Components .....	1-3
Accessories .....	1-3
<b>Technical Documents</b> .....	<b>1-4</b>
<b>Using Sokkia Software With Your Receiver</b> .....	<b>1-4</b>
<b>Getting Technical Support</b> .....	<b>1-4</b>
Website .....	1-6
<b>Getting Acquainted</b> .....	<b>2-1</b>
<b>Receiver Enclosure—Overview</b> .....	<b>2-1</b>
Receiver Enclosure—Display Panel .....	2-3
Receiver Enclosure—SIM Card Door .....	2-3
Receiver Enclosure — GRX3 Hardware Reset Button .....	2-4
Receiver Enclosure—Bottom Overview Labels .....	2-5
<b>Cables</b> .....	<b>2-6</b>
<b>Accessories</b> .....	<b>2-8</b>
<b>Battery</b> .....	<b>2-9</b>
<b>External Connectors</b> .....	<b>2-10</b>
Receiver Enclosure Top—Connectors .....	2-10
Receiver Enclosure Bottom—Connectors .....	2-11
<b>Display Panel</b> .....	<b>3-1</b>
<b>Power Button</b> .....	<b>3-1</b>
<b>LED Display Panel</b> .....	<b>3-2</b>
<b>Receiver Status LEDs</b> .....	<b>3-3</b>
Status LED .....	3-3
Recording LED .....	3-4
<b>Communication LEDs</b> .....	<b>3-5</b>
Bluetooth LED .....	3-5
Cellular LED .....	3-6
Radio LED .....	3-6
<b>Battery LED</b> .....	<b>3-8</b>
<b>Managing Power</b> .....	<b>4-1</b>
<b>Turning the Receiver On/Off</b> .....	<b>4-1</b>

<b>Powering the Receiver</b> .....	<b>4-1</b>
Operating Hours .....	4-2
<b>Charging the Battery</b> .....	<b>4-3</b>
Battery Charging Temperatures .....	4-3
<b>Surveying While Charging</b> .....	<b>4-3</b>
<b>Using an External Power Source</b> .....	<b>4-4</b>
Insufficient Power .....	4-4
<b>Configuration</b> .....	<b>5-1</b>
<b>Installing Sokkia Receiver Utility (SRU)</b> .....	<b>5-1</b>
<b>Loading New Firmware</b> .....	<b>5-2</b>
<b>Option Authorization Files</b> .....	<b>5-7</b>
Checking the Receiver's OAF .....	5-7
Loading an OAF .....	5-9
<b>Performing a Factory Reset</b> .....	<b>5-12</b>
Perform a Factory Reset Using SRU .....	5-12
Perform a Factory Reset Using the LED Display .....	5-13
<b>Using TILT Correction</b> .....	<b>5-14</b>
HIMU Calibration .....	5-15
<b>System Setup</b> .....	<b>6-1</b>
<b>Setting Up the Base Receiver</b> .....	<b>6-1</b>
<b>Setting Up the Rover Receiver</b> .....	<b>6-3</b>
<b>Using GRX3 with External Antenna</b> .....	<b>6-5</b>
<b>Measuring Antenna Height</b> .....	<b>6-6</b>
<b>Collecting Data</b> .....	<b>7-1</b>
<b>Memory</b> .....	<b>7-1</b>
<b>Setting Recording Parameters</b> .....	<b>7-1</b>
<b>Logging Rates</b> .....	<b>7-1</b>
<b>Recording Data</b> .....	<b>7-1</b>
Recording Data via the LED Display Panel .....	7-1
Recording Data Using Sokkia Receiver Utility (SRU) .....	7-2
<b>Managing Files</b> .....	<b>7-5</b>
USB Connection Specifics .....	7-5
Downloading Data Files Using SRU .....	7-10
Deleting Data Files from the Receiver Memory Using SRU .....	7-11
<b>Troubleshooting</b> .....	<b>8-1</b>
<b>Check This First</b> .....	<b>8-1</b>
<b>Powering Problems</b> .....	<b>8-1</b>
<b>Receiver Problems</b> .....	<b>8-2</b>

<b>Bluetooth Problems</b> .....	<b>8-5</b>
<b>SRU Problems</b> .....	<b>8-6</b>
<b>Cleaning and Storing the Receiver</b> .....	<b>8-7</b>
<b>Getting Customer Support</b> .....	<b>8-7</b>
<b>Specifications</b> .....	<b>9-1</b>
<b>General Details</b> .....	<b>9-1</b>
<b>R2 Lite UHF Internal Modem Board Details (Optional)</b> .....	<b>9-7</b>
<b>General Recommendation for Highly Reliable Radio Links</b> .....	<b>9-7</b>
<b>Bluetooth Module Details</b> .....	<b>9-8</b>
<b>Connector Specifications</b> .....	<b>9-8</b>
Radio (Modem) RF Connector .....	9-9
Cellular Module RF Connector .....	9-9
Power Connector .....	9-9
Serial RS-232 Connector .....	9-10
Micro-USB Connector .....	9-11
<b>Product Identification</b> .....	<b>10-1</b>
<b>Safety Warnings</b> .....	<b>11-1</b>
<b>General Warnings</b> .....	<b>11-1</b>
<b>Battery Pack Warnings</b> .....	<b>11-1</b>
<b>Receiver Warnings</b> .....	<b>11-2</b>
<b>Usage Warnings</b> .....	<b>11-2</b>
<b>Regulatory</b> .....	<b>12-1</b>
<b>FCC Compliance</b> .....	<b>12-1</b>
<b>ISED Canada Compliance</b> .....	<b>12-1</b>
<b>Community of Europe Compliance</b> .....	<b>12-2</b>
European Community Declaration of Conformity .....	12-2
Restrictions on Use .....	12-2
Product Conformity .....	12-2
<b>Declaration of Conformity (Radio Equipment Directive 2014/53/EU)</b> .....	<b>12-3</b>
<b>WEEE Directive</b> .....	<b>12-4</b>
<b>Japan Bluetooth SiteComm Module Compliance</b> .....	<b>12-4</b>
<b>Bluetooth Transmission Statements/Compliance</b> .....	<b>12-5</b>
<b>Warranty</b> .....	<b>13-1</b>

# Preface

Thank you for purchasing this Sokkia product. The materials available in this Manual (the “Manual”) have been prepared by Topcon Positioning Systems, Inc. (“TPS”) for owners of Sokkia products and are designed to assist owners with the use of the receiver and its use is subject to these terms and conditions (the “Terms and Conditions”).



**NOTICE** Please read the terms and conditions carefully.

---

## Terms and Conditions

### Use

This product is designed to be used by a professional. The user should have a good knowledge of the safe use of the product and implement the types of safety procedures recommended by the local government protection agency for both private use and commercial job sites.

### Copyrights

All information contained in this Manual is the intellectual property of and copyrighted material of TPS. All rights are reserved. Do not use, access, copy, store, display, create derivative works of, sell, modify, publish, distribute or allow any third party access to, any graphics, content, information or data in this Manual without TPS’ express written consent and may only use such information for the care and operation of the receiver. The information and data in this Manual are a valuable asset of TPS and are developed by the expenditure of considerable work, time and money and are the result of original selection, coordination and arrangement by TPS.

### Trademarks

Sokkia®, Sokkia® GNSS Receiver, GeoPro, Topcon Integrated Leveling Technology™ (TILT), Fence Antenna® technology, Vanguard Technology™, SiteComm, Quartz Lock Loop™ TopNET®, MAGNET® Field, Topcon® and Topcon Positioning Systems™ are trademarks or registered trademarks of TPS. Windows® is a registered trademark of Microsoft Corporation. The Bluetooth® word mark and logos are owned by Bluetooth SIG, Inc. and any use of such marks by Topcon Positioning Systems, Inc. is used under license. Other product and company names mentioned herein may be trademarks of their respective owners.

### Disclaimer of Warranty

EXCEPT FOR ANY WARRANTIES IN AN APPENDIX OR A WARRANTY CARD ACCOMPANYING THE PRODUCT, THIS MANUAL AND THE RECEIVER ARE PROVIDED “AS-IS.” THERE ARE NO OTHER WARRANTIES. TPS DISCLAIMS ANY IMPLIED WARRANTY OF MERCHANTABILITY OR FITNESS FOR ANY PARTICULAR USE OR PURPOSE. TPS AND ITS DISTRIBUTORS SHALL NOT BE LIABLE FOR TECHNICAL OR EDITORIAL ERRORS OR OMISSIONS CONTAINED HEREIN; NOR FOR INCIDENTAL OR CONSEQUENTIAL DAMAGES RESULTING FROM THE FURNISHING, PERFORMANCE OR USE OF THIS MATERIAL OR THE RECEIVER. SUCH DISCLAIMED DAMAGES INCLUDE BUT ARE NOT LIMITED TO LOSS OF TIME, LOSS OR DESTRUCTION OF DATA, LOSS OF PROFIT, SAVINGS OR REVENUE, OR LOSS OF THE PRODUCT’S USE. IN ADDITION TPS IS NOT RESPONSIBLE OR LIABLE FOR DAMAGES OR COSTS INCURRED IN CONNECTION WITH OBTAINING SUBSTITUTE PRODUCTS OR SOFTWARE, CLAIMS BY OTHERS, INCONVENIENCE, OR

ANY OTHER COSTS. IN ANY EVENT, TPS SHALL HAVE NO LIABILITY FOR DAMAGES OR OTHERWISE TO YOU OR ANY OTHER PERSON OR ENTITY IN EXCESS OF THE PURCHASE PRICE FOR THE RECEIVER.

## License Agreement

Use of any computer programs or software supplied by TPS or downloaded from a TPS website (the “Software”) in connection with the receiver constitutes acceptance of these Terms and Conditions in this Manual and an agreement to abide by these Terms and Conditions. The user is granted a personal, non-exclusive, non-transferable license to use such Software under the terms stated herein and in any case only with a single receiver or single computer. You may not assign or transfer the Software or this license without the express written consent of TPS. This license is effective until terminated. You may terminate the license at any time by destroying the Software and Manual. TPS may terminate the license if you fail to comply with any of the Terms or Conditions. You agree to destroy the Software and manual upon termination of the use of the receiver. All ownership, copyright and other intellectual property rights in and to the Software belong to TPS. If these license terms are not acceptable, return any unused software and manual.

## Website; Other Statements

No statement contained at the TPS website (or any other website) or in any other advertisements or TPS literature or made by an employee or independent contractor of TPS modifies these Terms and Conditions (including the Software license, warranty and limitation of liability).

## Technical Documentation and Utility Software

On the Sokkia Support website (<https://us.sokkia.com/sokkia-care-products/sru-sokkia-receiver-utility>), you can download technical documentation, training material, and various utility software to help you set up and use your Sokkia product. The website also offers registration resources, training, and technical assistance.

Although the support documentation, firmware and utility software for the Sokkia GRX3 can be found at the Sokkia Care site, the product registration is done via the myTopcon site/or by using the myTopcon NOW! app. It is free to create an account and register.

## Safety

Improper use of the receiver can lead to injury to persons or property and/or malfunction of the product. The receiver should only be repaired by authorized TPS warranty service centers.

## Miscellaneous

The above Terms and Conditions may be amended, modified, superseded or canceled, at any time by TPS. The above Terms and Conditions will be governed by and construed in accordance with, the laws of the State of California, without reference to conflict of laws.

## Manual Conventions

This manual uses the following conventions:

Convention	Description	Example
Bold	Menu or drop-down menu selection	<b>File &gt; Exit</b> (Click the <b>File</b> menu and click <b>Exit</b> )
	Name of a dialog box or screen	From the <b>Connection</b> screen...
	Button or key commands	Click <b>Finish</b> .
Mono	User supplied text or variable	Type <code>guest</code> and click <b>Enter</b> .
<i>Italic</i>	Reference to another manual or help document	Refer to the <i><b>Sokkia Reference Manual</b></i> .



### NOTE

Further information to note about system configuration, maintenance or setup.



### NOTICE

Supplementary information that can have an adverse affect on system operation, system performance, data integrity or measurements.



### CAUTION

Notification that an action has the potential to result in minor personal injury, system damage, loss of data or loss of warranty.



### WARNING

Notification that an action has the potential to result in personal injury or property damage.



### DANGER

Notification that an action has the potential to result in severe personal injury or death.



# Introduction

The Sokkia GRX3 GNSS receiver is a compact, high-performing integrated GNSS receiver for static and kinematic land surveying applications. The receiver design includes 226 GNSS channel Vanguard Technology with Universal Tracking Channels and advanced integrated Fence Antenna technology. These technologies deliver world class positioning and navigation capability to your application by tracking signals with multiple frequencies and multi-constellation satellite systems such as GPS, GLONASS, BeiDou, QZSS, Galileo, NavIC, and SBAS.

To create a future proof, efficient positioning system this receiver combines; GNSS tracking capabilities, multiple-frequency RTK, DGPS and PPP solutions, extensive communication capabilities, a built-in 8 GB memory and an integrated internal battery.

Several unique features, including advanced multi-path mitigation, adjustable Phase Locked Loop (PLL) and Delay Locked Loop (DLL), offer reliable and versatile reception of weak signals even in degraded signal environments. The receiver also supports Quartz Lock Loop (QLL) technology for superior GNSS tracking in high-vibration environments.

The GRX3 receiver contains an internal HIMU (Hybrid Inertial Measurement Unit) module. This module measures tilt angles of the rover receiver. The angle values are used by the software application MAGNET Field for calculating the true projection of the rover antenna phase center on the ground.

The GRX3 GNSS Receiver offers complete IP67 protection against dust and water ingress, in addition to superior vibration and shock resistance. The Sokkia communication interface allows you to integrate GNSS performance and quickly deliver world class positioning and navigation support to your applications.



**Figure 1-1: GRX3 Receiver**

# GRX3 Features

The GRX3 GNSS receiver's advanced design provides simplified setup and maximum performance. The GRX3 receiver features are as follows:

- 226 GNSS channel Vanguard Technology with Universal Tracking Channels for multi-frequency tracking of multiple satellite constellations such as GPS, GLONASS, BeiDou, QZSS, Galileo, NavIC, and SBAS.
- Industry leading Fence Antenna technology
- Internal, non-removable battery
- Internal UHF radio modem
- Optional Multi-band 4G/3G/2G internal cellular module
- Integrated Bluetooth, multi-channel SiteComm technology
- Interface for controlling and viewing data logging through the LED display
- Topnet Live Starpoint (Pro) global Precise Point Positioning (PPP) correction service
- TILT—Topcon Integrated Leveling Technology
- External power, USB and serial-data ports
- External GNSS antenna connector for GRX3 series receivers without an internal cellular module
- External cellular module antenna connector for GRX3 series receivers with an internal cellular module
- Internal 8 GB memory storage
- Virtual serial port via USB
- Data access using USB

The GRX3 comes in one of the following configurations:

- No cellular module
- Integrated 4G/LTE cellular module only
- R2 Lite UHF radio, with integrated 4G/LTE cellular module
- Alinco UHF radio (available in Japan)
- Alinco UHF radio (available in Japan), with integrated 4G/LTE cellular module

# Unpacking Your Receiver Kit

This section describes the documentation, standard kit components<sup>1</sup> and accessories that accompany your receiver. When you unpack your receiver kit, verify that you received the items listed in this section. If any items are missing or damaged, contact your local Sokkia dealer. See “Getting Technical Support” on page 1-4.

## Standard Kit Components

Table 1-1 lists the standard kit components for the GRX3. For more information about the included cables, see “Cables” on page 2-6.

**Table 1-1. GRX3 Standard Kit Components**

GRX3 Receiver	Power Cable
Power Adapter	Wall Charger Cable
Micro-USB Cable	Serial Cable
GRX3 GNSS Receiver Quick Reference Card (P/N 1030648-01) – Describes the LED behavior and technical content.	Warranty Card
Radio Antenna	Cellular Antenna (with cellular variants only)

## Accessories

Sokkia offers a wide variety of accessories specially designed to improve system flexibility and job site efficiency. For more details on the optional accessories available for GRX3, contact your Sokkia dealer.

Table 1-2 lists the accessories available for the GRX3. For more information about accessories, see “Accessories” on page 2-8.

**Table 1-2. GRX3 Accessories**

Radio Antenna	Rover Pole
External Antenna Cable	Prism
External Cellular Antenna	Fixed Height Heavy Duty Tripod
Rover Pole Offset Adapters	Economy Tripod
Tribrach with Plug Adapter	Tape Measure
Hand-Held Controller and Brackets	Prism Adapter

1. Components in the standard kits may differ based on your country or region. Contact your local Sokkia dealer to inquire about items included in your regional standard kit and accessories that are available with the receiver.

# Technical Documents

The following documents will help you set up and use your new receiver.

- *GRX3 GNSS Receiver Operator's Manual* (this document)—contains detailed information on how to use your new receiver. You can download the document from the Sokkia Care support site (<https://us.sokkia.com/sokkia-care>).
- *GRX3 GNSS Receiver Quick Reference Card (P/N 1030648-01)*—contains basic hardware and LED descriptions, along with safety and regulatory statements. This guide is available in your standard kit package.
- *Sokkia Receiver Utility (SRU) Help*—an on-screen help document embedded in the software that contains detailed information on how to use the SRU software. For more information about the SRU software, see "Using Sokkia Software With Your Receiver".

## Using Sokkia Software With Your Receiver

Use the GRX3 receiver in conjunction with the Sokkia Receiver Utility (SRU) and MAGNET Field data collection software or Pocket 3D machine control system applications for a precision positioning solution. Sokkia software enables you to configure the receiver and other external devices, manage files, collect data and perform survey and construction work flows.

The Sokkia Receiver Utility (SRU) is a software program that enables users to configure and update their GNSS receivers and peripheral devices. You can install it on desktop computers and data controllers. You can download this program from Sokkia Care (<https://us.sokkia.com/sokkia-care>). The help document for SRU is embedded in the software.

Topcon's MAGNET Field and Sokkia GeoPro Field software for data controllers provides real-time communication, cloud storage, data collection and exchange and field solutions—such as topographic staking, roads, calculations and more.

Pocket 3D is a machine control system application for the survey and construction markets. The software runs on data controllers with Windows CE and mobile platforms. Pocket 3D simplifies data collection, allowing you to check cuts and fills, layout points and survey all or part of the job site quickly and efficiently.

Contact your Sokkia dealer for more information about Sokkia field data collection software for the surveying and construction markets.

## Getting Technical Support

Before contacting a Sokkia customer representative about any problems with the receiver, see "Troubleshooting" on page 8-1 for some solutions that may fix the issue.

Contact your local Sokkia dealer or visit Sokkia Care (<https://us.sokkia.com/sokkia-care>) for technical support.



### NOTICE

For quick and effective support, provide a detailed description of the problem.

---

When contacting Sokkia for technical assistance, provide the following information for better and faster service:

1. A description of the following:
  - The field operation that was being performed when the problem occurred.
  - Details of the unexpected behavior, symptoms and any error messages that precede or follow the problem.
  - Problem occurrence frequency or patterns.
2. Gather your receiver information and configuration settings. To obtain the receiver information:
  - a. Install SRU on a hard drive of a field controller or personal computer.
  - b. Use a serial or USB cable for connection.
  - c. Run SRU, switch on the receiver.
  - d. Select **Device > Application Mode > Receiver Managing**.
  - e. Select **Device > Connect**.
  - f. Click the **Connect** button on the **Connection Parameters** screen to establish a communication to the receiver.
  - g. Click **Information**  on the Main menu of SRU.

The **Receiver Info** screen opens (Figure 1-2). It displays basic receiver information, such as hardware and firmware versions, RAM size, receiver ID, serial number and so forth.

- h. Click **Save to File**.

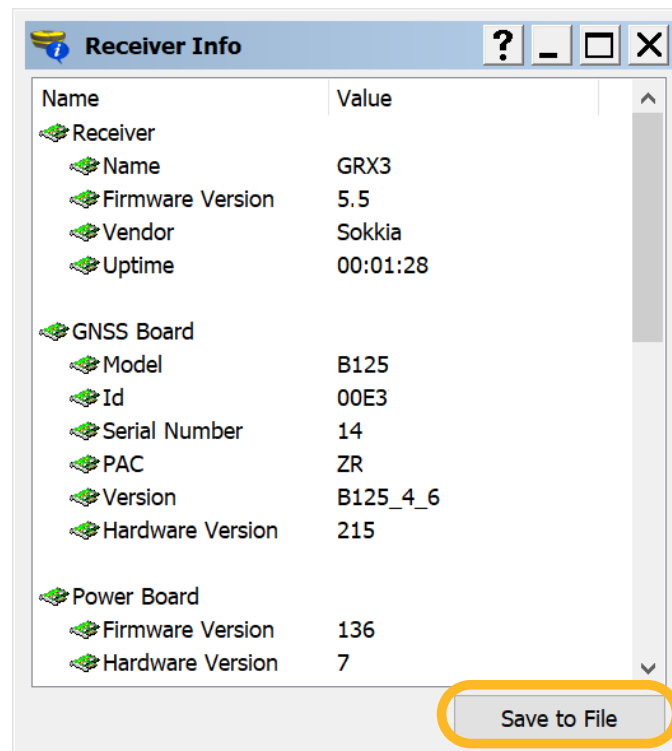

**Figure 1-2: Save Receiver Info to File**

- i. Enter a **File name** and click **Save** on the **Save As** window to save it to your computer.

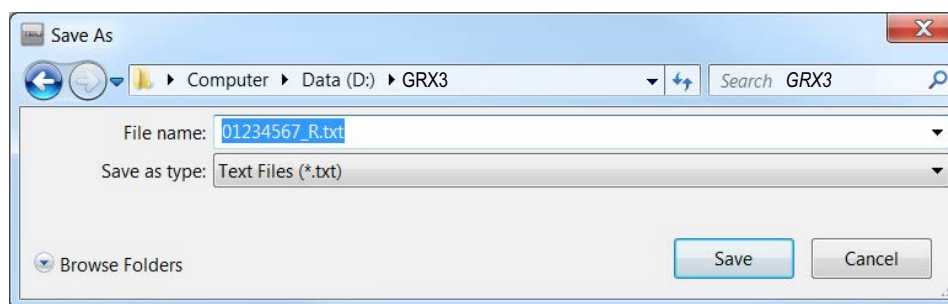

**Figure 1-3: Save Receiver Info**

3. Specifications of mobile devices and computers used in the field or office exhibiting the problem. These specifications should include model information, version number, operating system information, memory and storage capacity.
4. Information about the system software, including the version number and steps to reproduce the problem.
5. A description of the field environment and/or observation conditions when the problem occurred.

## Website

The Sokkia website provides current information about Sokkia's line of products. The support area of the website provides access to Sokkia field and office software, manuals and frequently asked questions. To access the Sokkia corporate website, visit <https://sokkia.com>.

The Sokkia Care support and training website provides support for Sokkia registered users. Sokkia Care provides information about Sokkia products, training, events, firmware and software updates and troubleshooting procedures. To access this content visit <https://us.sokkia.com/sokkia-care>.

# Getting Acquainted

The GRX3 receiver enclosure is fully sealed and may incorporate a GNSS receiver board, multiple modems, multiple antennas, a battery, memory storage and wireless communication modules that are enclosed in a rugged housing. The upper part of the receiver includes both GNSS and Bluetooth antennas that are covered by a Radome and is securely surrounded by a shock absorbing rubber bumper.

## Receiver Enclosure—Overview

Currently, there are five (5) configurations of the GRX3:

- No radio, no cellular module
- R2 Lite UHF radio
- R2 Lite UHF radio, with integrated 4G/LTE cellular module
- Alinco UHF radio (available in Japan)
- Alinco UHF radio (available in Japan), with integrated 4G/LTE cellular module

Figure 2-1 shows a GRX3 GNSS receiver **without** radio modems or a cellular module (P/N 1028556-02). The lower part of the receiver contains the **External GNSS antenna connector**. The **Reset** button is located under the **SIM card door** in the lower part of the receiver.

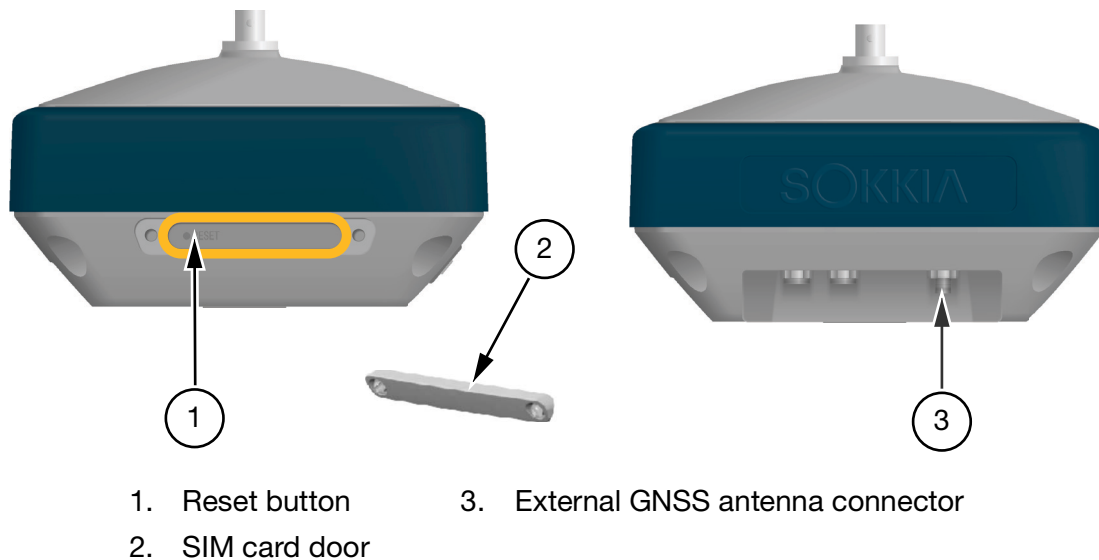

**Figure 2-1: GRX3 without Radio Modems or a Cellular Module**

Figure 2-2 shows a GRX3 GNSS receiver **with** an R2 Lite UHF modem (P/N 1028556-01) and **without** a cellular module. The upper part of the receiver includes a connector for the radio modem antenna. The lower part of the receiver contains the **external GNSS antenna connector**. The **Reset button** is located under the **SIM card door** in the lower part of the receiver.

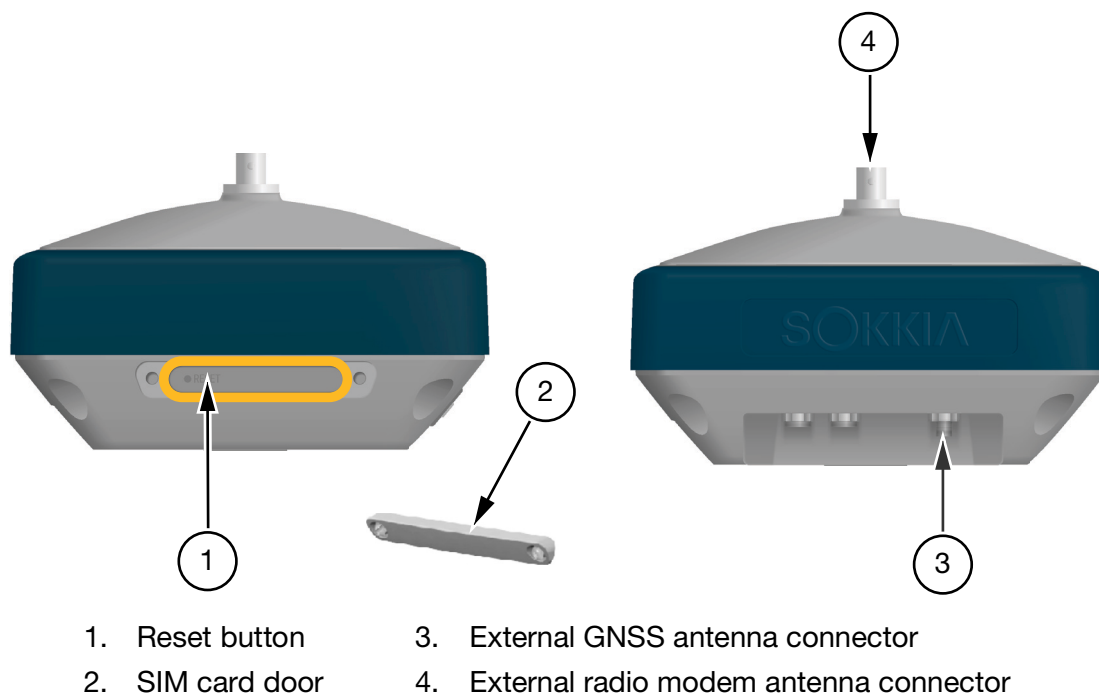

**Figure 2-2: GRX3 with a UHF Without a Cellular Module**

Figure 2-3 shows a GRX3 GNSS receiver **with** an R2 Lite UHF modem (P/N 1028556-05) and **with** a cellular module. The upper part of the receiver includes a connector for the radio modem antenna. The lower part of the receiver contains the **external cellular module antenna connector**. The **Reset button** and **SIM card slot** are located under the **SIM card door** in the lower part of the receiver.

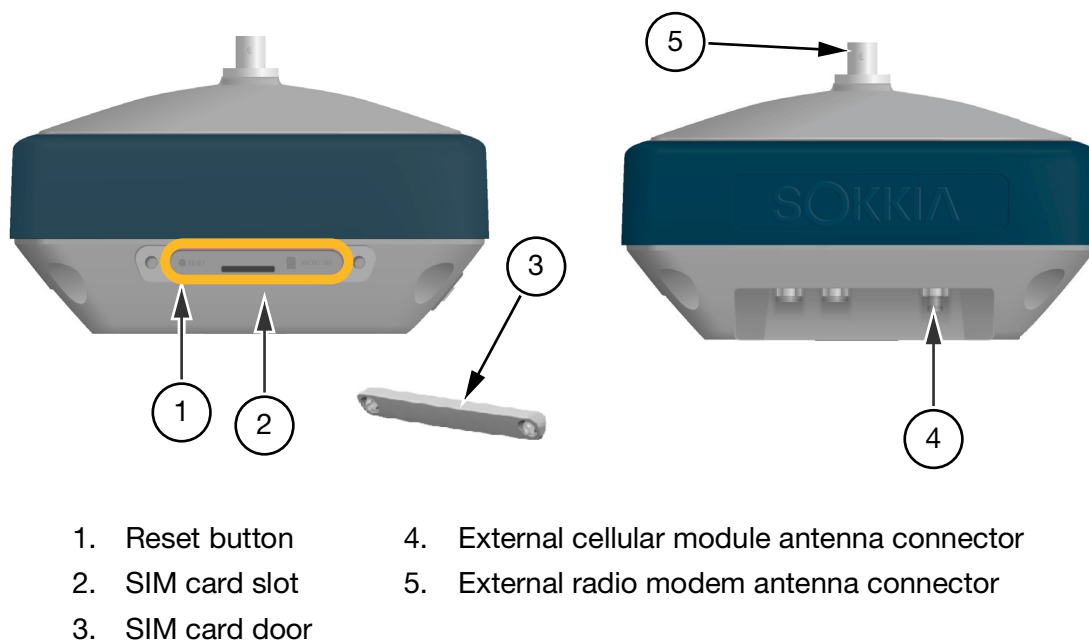
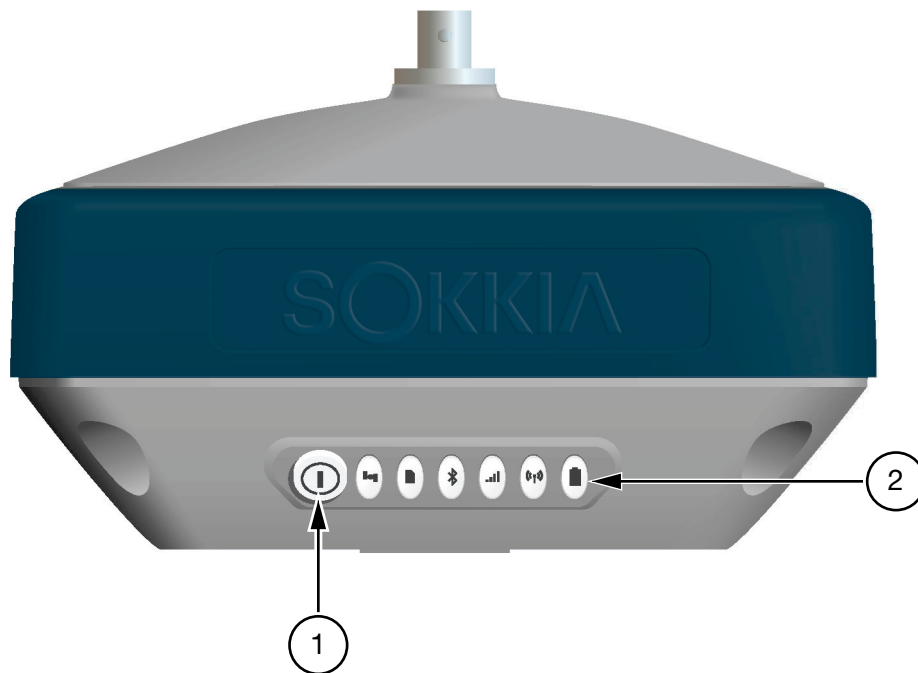

**Figure 2-3: GRX3 with a UHF With a Cellular Module**



## Receiver Enclosure—Display Panel

The receiver's lower part is made of a magnesium alloy and contains a display panel.



1. Power button    2. Display panel

**Figure 2-4: Lower Part of Receiver—Display Panel**

The display panel enables you to view the receiver's operational status. For more information about the display panel's operational status see "Display Panel" on page 3-1.

## Receiver Enclosure—SIM Card Door

The **SIM card door** (Figure 2-5 on page 2-4) is located to the left of the LED Display Panel. To remove the **SIM card door** from the GRX3 use a flat blade screwdriver and remove the two **screws**. The **Reset button** is located under the **SIM card door**. For the GRX3 receivers with cellular module(s) installed, the **SIM card slot** is located there, too.



### NOTICE

The GRX3 receiver's GSM functionality is enabled when the Micro-SIM Card is installed.



### NOTICE

Cellular operation is based on subscribed services.



### NOTICE

The SIM Card usually remains inside the receiver.

The cellular module with SIM card installed is accessed via MAGNET Field, Magnet Construct or SRU for configuration purposes. Additional Micro SIM cards can be purchased by the user.

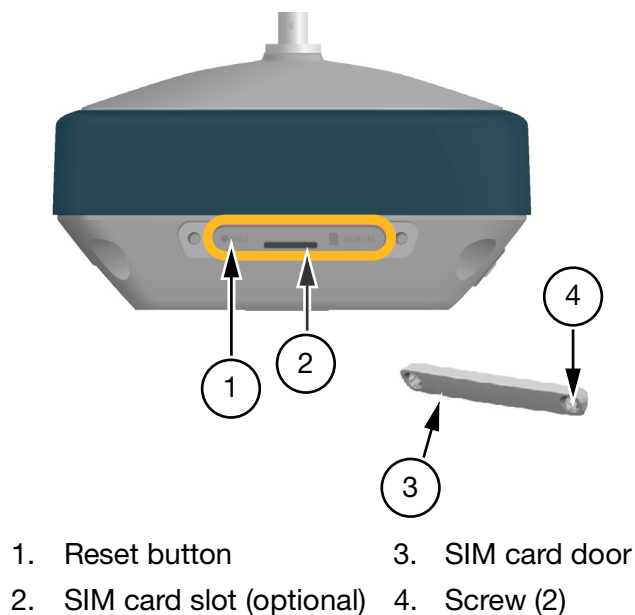

**Figure 2-5: Removing the SIM Card Door**

## Receiver Enclosure — GRX3 Hardware Reset Button

If the GREX3 receiver stops responding via the Power button (Figure 2-4 on page 2-3) or the external software—perform a hardware reset. A hardware reset should only be performed when the GNSS receiver is powered on and not otherwise responding.



### **WARNING**

A hardware reset does not erase the “.tps” data file(s) stored in the receiver’s internal memory and does not change the user’s settings entered in to the receiver.

To perform a hardware reset:

1. Remove the **SIM Card Door** using a flat blade driver to remove the two screws (Figure 2-5).
2. Insert a paper clip or any pointed stick small enough to fit into the pinhole of the **Reset Button**.
3. Gently press the **Reset Button** for about one second until the GRX3 powers off.
4. After the **Reset Button** is released, the GNSS receiver is automatically powered on.
5. Close the **SIM Card Door** and install the two **screws**.

## Receiver Enclosure—Bottom Overview Labels

1. Reset button
2. SIM card slot (optional)
3. SIM card door
4. Screw (2)

Attached to the bottom of the receiver enclosure are the regulatory and product identification labels. The product identification label contains the serial number (S/N) and part number (P/N) (Figure 2-6) for the receiver.

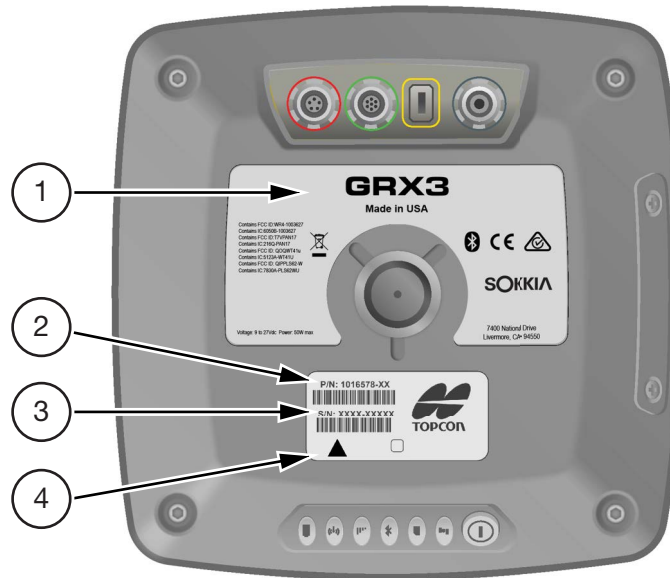

1. Regulatory label
2. Part number
3. Serial number
4. Product identification label

**Figure 2-6: Bottom Enclosure Overview with Product Identification and Regulatory Labels**

# Cables

The GRX3<sup>1</sup> package includes a power supply cable, a USB cable and a power adapter. Table 2-1 describes the cables included with your receiver—depending on your regional standard kit configuration. Make sure to contact your local Sokkia dealer to inquire about standard items included in your receiver kit.



## NOTE

Align the keyways when connecting the power/serial cable to the receiver connectors. To disconnect the cable, push the cable in and then gently remove the cable.

**Table 2-1. Receiver Cables**

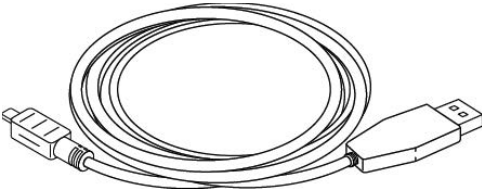
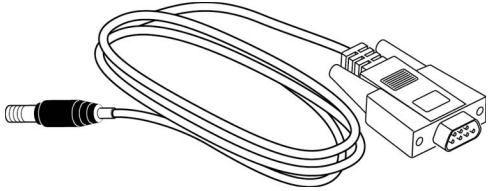
Cable Description	Cable Illustration
<p>Power Charge Cable(s)</p> <p>These two cables connect to the power adapter to a grounded outlet. Several options are available for the power charger cable based on your country. To purchase this cable, contact your Sokkia dealer. Refer to this part numbers:</p> <p>P/N 1005793-01 - Cable, Power Charger (US)</p> <p>P/N 1005794-01 - Cable, Power Charger (EUR)</p> <p>P/N 1021180-01 - Cable, Power Charger (AUS)</p>	<p>See Figure 2-7 on page 2-7 and Figure 2-8 on page 2-7.</p>
<p>Receiver Power/Charging Cable</p> <p>Connects the receiver and the power supply unit via SAE connectors for battery charging.</p> <p>P/N 14-008016-04LF</p>	
<p>Micro-USB Cable</p> <p>Connects the receiver to an external device (controller or computer) for data transfer and receiver configuration.</p> <p>P/N 1013602-01</p>	
<p>Serial Cable</p> <p>Connects the receiver to an external device (controller or computer) for data transfer and receiver configuration.</p> <p>P/N 14-008005-03</p>	

1. Components in the standard kit may differ based on your region. Contact your local Sokkia dealer to inquire about items included in your regional standard kit and accessories that are available with the receiver.

**Table 2-1. Receiver Cables (Continued)**

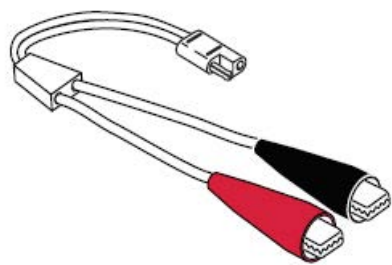
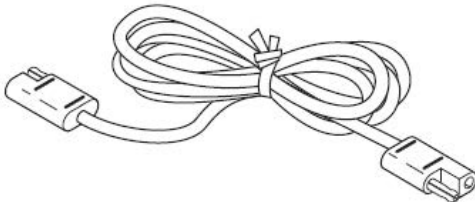
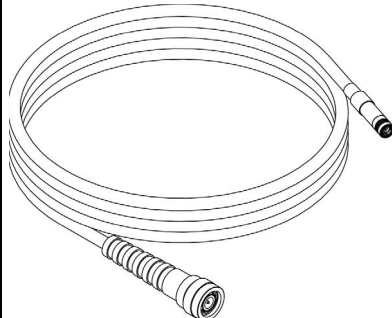
Cable Description	Cable Illustration
<p>Alligator Clips Cable (Optional)                      Connects any 12-volt DC power source to the receiver via the SAE cable.                      P/N 14-008025-01</p>	
<p>SAE-to-SAE extension cable (Optional)                      Connects SAE connectors over longer distances.                      P/N 14-008022-01</p>	
<p>External Antenna Cable (Optional)                      Connects the receiver to an external Sokkia GNSS antenna.                      P/N 1006447-01</p>	

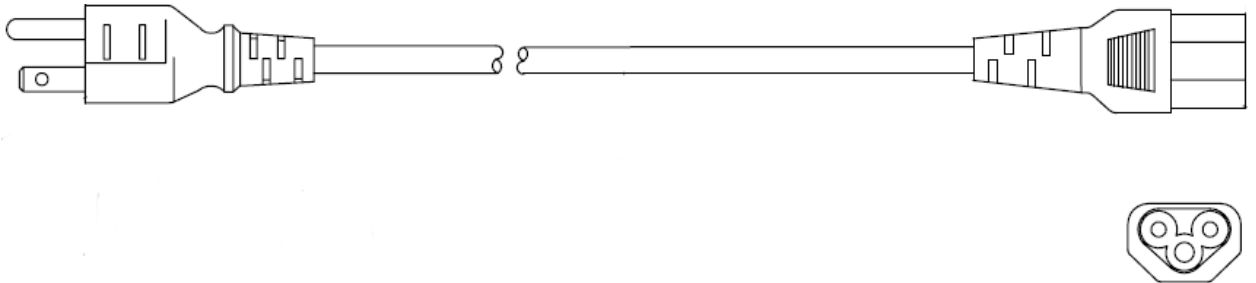

**Figure 2-7: Power Charge Cable—US P/N 1005793-01**

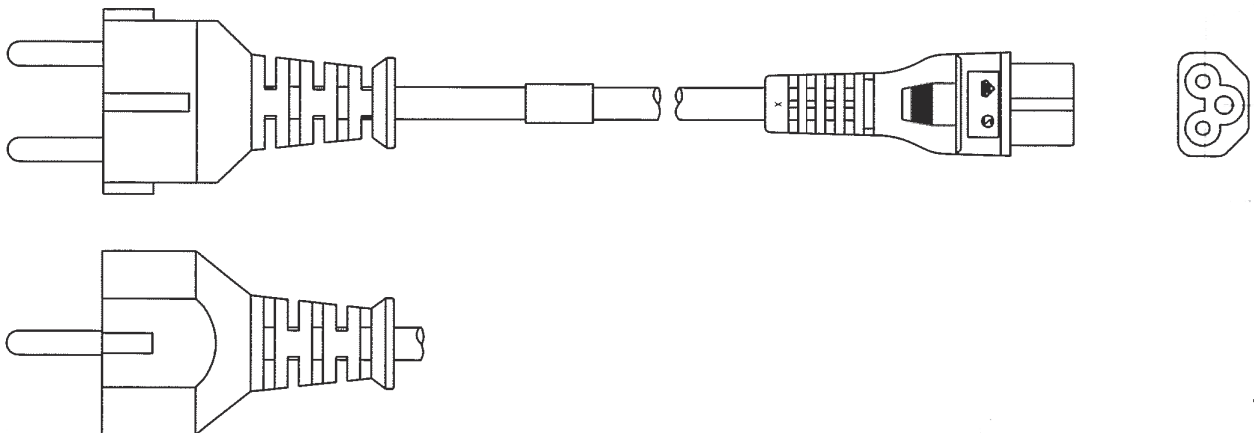

**Figure 2-8: Power Charge Cable—Europe P/N 1005794-01**

# Accessories

Sokkia offers a wide variety of accessories specially designed to improve system flexibility and job site efficiency. For more details about the available accessories, contact your Sokkia dealer.<sup>1</sup>

- **Power Supply Unit** (P/N 1005555-01): This item charges the internal battery when connected to a grounded outlet. This unit converts the Alternating Current (AC), normally supplied from an electrical outlet, to Direct Current (DC) for charging the battery and/or powering the receiver.
- **Modem Antenna:** The UHF antenna is a BNC connection, the UHF frequency is 420-450 MHz (P/N 30-070003-01) and UHF frequency is 440-470 MHz (P/N 30-050501-01).
- **Cell Antenna** (P/N 1030630-01): This antenna is for use with the GRX3 versions that contain the integrated cellular modem. See Figure 2-3 on page 2-2 for the antenna location.



## NOTE

For additional information about antenna part and serial numbers, see Table 10-1 on page 10-1.

- **Universal Tribrach and Tribrach Adapter**<sup>2</sup> (P/N 22-006008-01 and P/N 22-006009-01): These items level the tripod and secure the receiver or antenna to the tripod.
- **Precision Tribrach Adapter:** This item precisely centers, aligns and levels the tripod over a point. The horizontal spacer (P/N 51842) inserts into the precision tribrach and allows the receiver to sit securely on the precision tribrach.
- **Wooden Tripod** (P/N 751252)
- **Heavy Duty Tripod** (P/N 22-050501-01)
- **Two (2) Meter Fixed Height Rover Pole** (P/N 808016)
- **Field Controller:** This item allows the GRX3 Base and Rover systems to be configured and monitored directly in the field. Use the Sokkia Receiver Utility (SRU) to configure the receiver and Topcon's MAGNET Field and Sokkia GeoPro Field software.
- **MAGNET and Pocket 3D machine control software:** These items can be used to operate the receiver. See the *SRU Help* (embedded in the software) or the help files in the field collection software for more information.
- **Fusion Positioning Adapter** (P/N 1003241-01)
- **100 mm Prism Spacer** (P/N 51949)
- **Tape Measure** (P/N 22-050902-01) HV1034DM 3/4 x 12 ft./3.7 Meters PWR Tape 10ths.

1. Some accessories may be included in the standard kit for your region. Contact your dealer for details.

2. The universal tribrach and tribrach adapter are not needed when using a heavy duty tripod.

# Battery

The receiver has an internal, non-removable, rechargeable battery. The internal battery has **two** battery cells (packs) (Figure 2-9). For more information about using the battery see “Managing Power” on page 4-1.

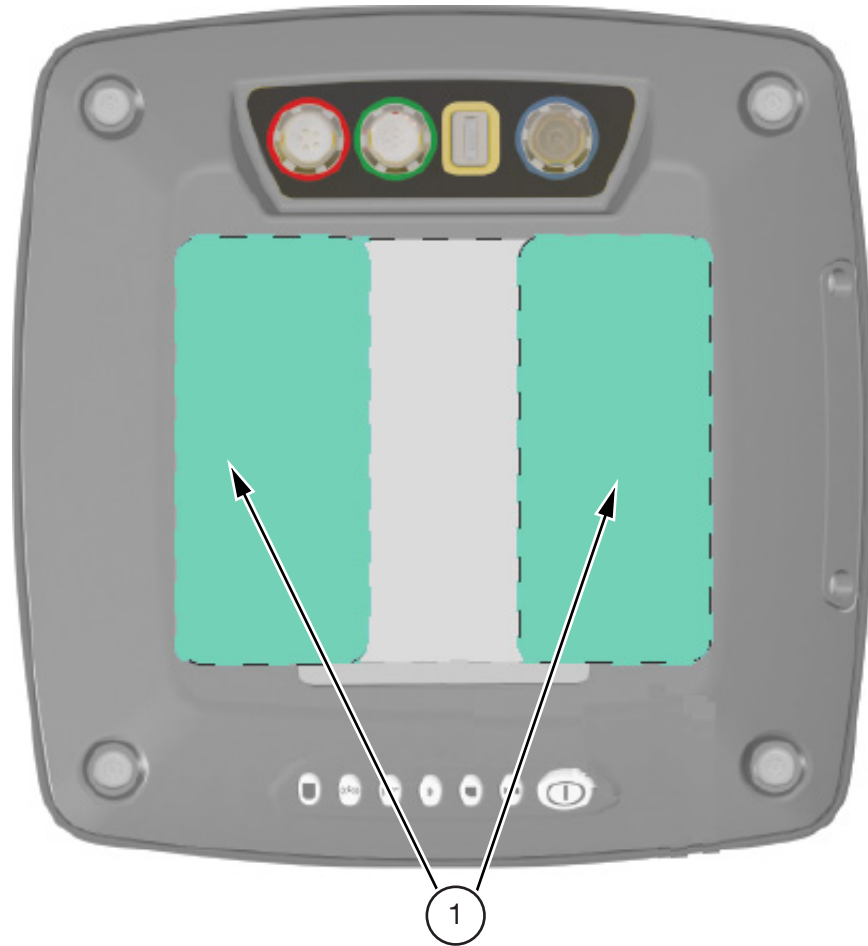

1. Internal battery  
(two battery cells/packs—bottom view)

**Figure 2-9: GRX3 Internal Battery**

# External Connectors

The GRX3 has the following external connectors.

## Receiver Enclosure Top—Connectors

Radio Modem Antenna Connector—The radio antenna of the UHF radio modem plugs to the external antenna connector on the GRX3 radome. The radio antenna uses a reverse polarity TNC or BNC connection depending on the installed radio modem. For additional Specification information see Table 9-3 on page 9-8.

- A BNC connector is used for the UHF modem (Figure 2-10).

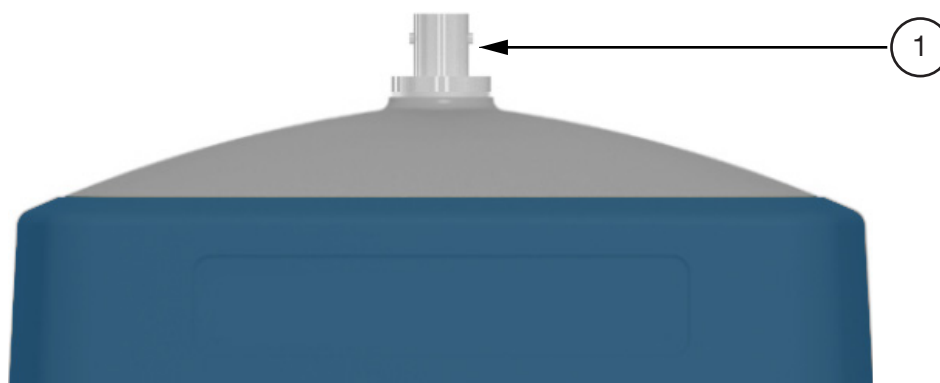

1. BNC connector

**Figure 2-10: BNC Connector for UHF Modem**



## Receiver Enclosure Bottom—Connectors

See Figure 2-11.

- Power connector—outlined in red. This connector is used to connect the receiver to an external power source. This connector can also be used to charge the battery. The body of the connector on the corresponding cable is red. For additional specification information see Table 9-6 on page 9-10.
- Serial connector—outlined in green. This connector is used for data communication between the receiver and an external device. For additional specification information see Table 9-7 on page 9-10.
- Micro-USB connector—outlined in yellow. This connector is used for high-speed data transfer and communication between the receiver and an external device. For additional specification information see Table 9-8 on page 9-11.
- GNSS radio antenna connector (optional, available only within non-cellular receivers)—outlined in blue. The SMB connector that is used to connect an external GNSS antenna for use in both base and rover stations. This connector is not present in a GRX3 receiver with a cell module.
- Cellular module antenna connector (optional, present only within integrated cellular receivers)—outlined in blue. The SMA connector that is used to connect an external cellular antenna. This connector is present in the GRX3 series with cellular module(s).

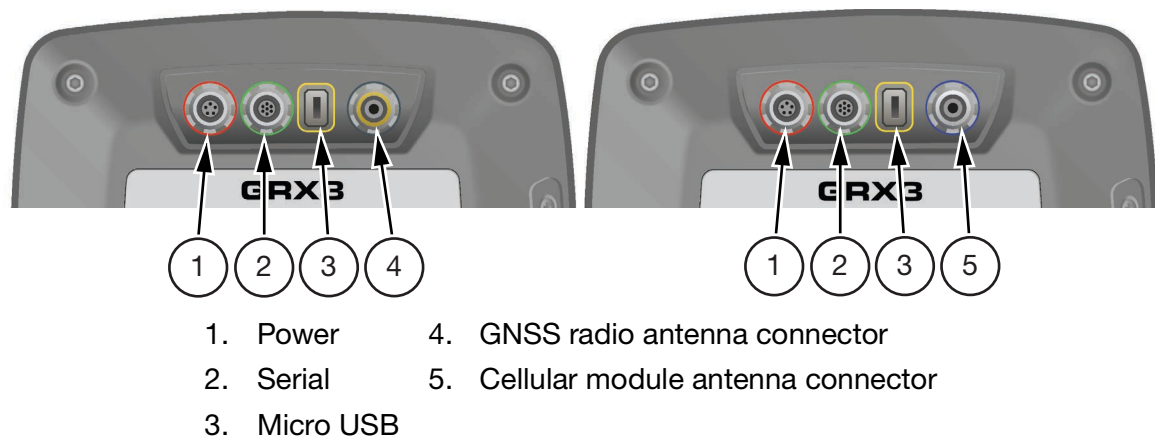

**Figure 2-11: Receiver Enclosure Bottom-Connectors (based on configuration)**

# Display Panel

The receiver has a highly-visible display panel with single-button operation. The LED display panel (Figure 3-1) allows for control of receiver power and data recording. The LEDs display the status of the satellite tracking, recording raw data to the internal memory, Bluetooth connections, cellular module status and battery state of charge. This chapter describes the different LED blink patterns and what they mean.

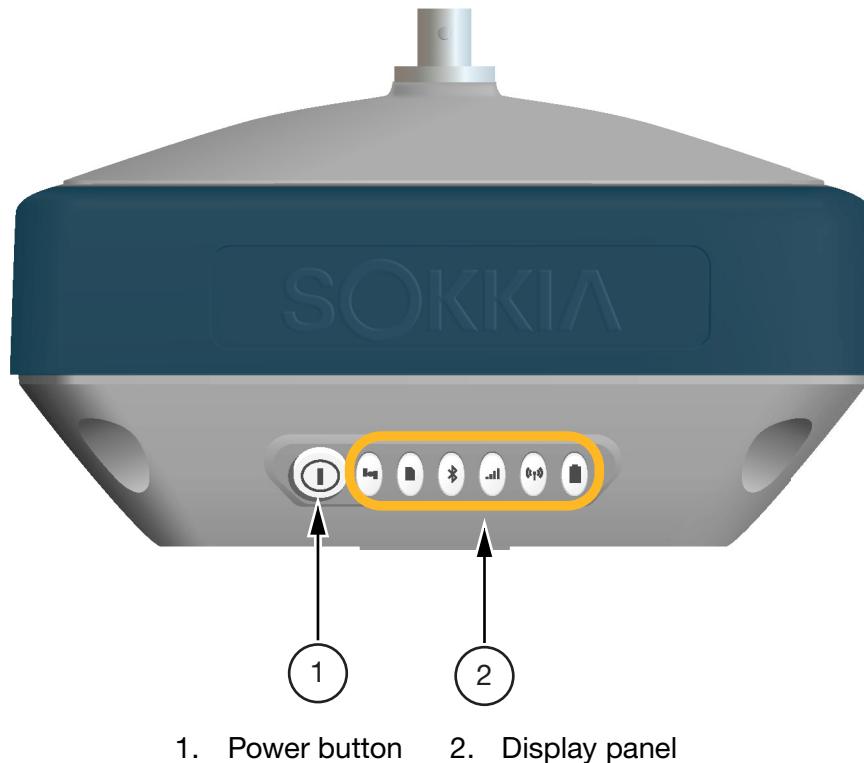

**Figure 3-1: LED Display and Power Button Panel**

## Power Button

The power button (Figure 3-1) performs multiple functions. The duration in which the button is pressed and held determines how the receiver will perform. While pressing the button, the LED panel indicates the selected operation using particular LEDs. Table 3-1 describes how to use the power button.

**Table 3-1. Power Button Functions and Descriptions**

Function	Press Button	LED Description
Power On	2 seconds	Release the Power button when the STAT LED turns solid green. The Power LED blinks until startup completes. After that the LED light is solid green, if the external power source is connected to the receiver. If the external power source is not connected to the receiver, the LED is OFF.

**Table 3-1. Power Button Functions and Descriptions (Continued)**

Function	Press Button	LED Description
Power Off	3-10 seconds	Press and hold the Power button for more than 3 seconds but not more than 10 seconds. Release the Power button when the STAT LED turns yellow.
Start/Stop Data Logging	Press the Power button three times in a row within 2 seconds	Refer to the REC (Recording) LED description.
Toggling between Static and Kinematic post-processing modes	Press the Power button three times in a row within 1 second.	Refer to the REC (Recording) LED description. This function is available for "Occupation mode switch" only. See Sokkia Receiver Utility (SRU) Help.
Resetting Parameters	10-15 seconds	Release the Power button when STAT LED turns magenta.
Performing Factory Reset	30-35 seconds	Release the Power button when STAT LED turns red.
Emergency Power Off (when external power source is not connected to receiver)	45-70 seconds	Release the Power button when all the LEDs are OFF.



**NOTE**

A delay of several seconds occurs between the last clicking of the Power button and first blinking/last blinking of the REC LED.





**NOTE**

When using external power, the Power LED is solid green except for startup and shutdown procedures.

## LED Display Panel

**Table 3-2. LED Display**

Display	LED Icon Key		
	SOLID	BLINKING	OFF
			

# Receiver Status LEDs



There are six status LEDs to provide information about satellite tracking, recording, Bluetooth, cellular, radio and remaining internal battery life. This section describes the color and behavior of each LED.

## Status LED



The tracking status LED displays the status of tracked satellites when the receiver is on.

**Table 3-3. Status LED Descriptions**

Display	LED Color	Description
	Green Blink	One blink per tracked GPS satellite.
	Yellow Blink	One blink per tracked GLONASS satellite.
	Cyan Blink	One blink per tracked Galileo satellite.
	Magenta Blink	One blink per tracked BeiDou satellite.
	Blue Blink	One blink per tracked QZSS satellite.
	White Blink	One blink per tracked L-band Satellite.
	Red Blink	One blink per second when there are no tracked satellites or solutions. Two blinks per second when the receiver is in exception mode. Otherwise, LED is dark.
	Red-Green-Yellow	OAF is expired.

# Recording LED



The recording LED indicates if memory storage is being used and displays the current survey mode (static or kinematic) when the Occupation mode switch is selected.

**Table 3-4. Recording LED Descriptions**

Display	LED Color	Description
<b>LED blink mode switch is selected</b>		
	Green Blink	File logging is in progress. Each blink indicates data is being written to memory.
	Blue Blink	File deletion is in progress.
	Magenta Blink (two blinks per second)	Memory storage formatting is in progress.
	Magenta Blink (one blink per second)	File system checking is in progress.
	Magenta Blink (one blink per two seconds)	File system mounting is in progress.
	Red Solid	File logging problem. No free memory or hardware problem with data recording. LED is off when file is not logging data.
<b>Occupation mode switch is selected</b>		
	Green Blink	File logging is in progress. The Static mode is the current post-processing mode.
	Yellow Bink	File logging is in progress. The Kinematic mode is the current post-processing mode.

**Table 3-4. Recording LED Descriptions (Continued)**

	<p>Red Solid</p>	<p>File logging problem. No free memory or hardware problem with data recording. LED is off when file is not logging data.</p>
---	------------------	--

## Communication LEDs



The communication LEDs display the status of the wireless activity. The following tables describe the communication activity for two use cases: **Bluetooth and Radio** modems.

### Bluetooth LED



The Bluetooth LED displays the status of the Bluetooth activity. Table 3-5 describes the activity.

**Table 3-5. Bluetooth LED Descriptions**

Display	LED Color	Description
	<p>Blue Blink</p>	<p>Bluetooth is on and waiting for a connection.</p>
	<p>Blue Solid</p>	<p>A single Bluetooth connection has been established.</p>
	<p>Blue Solid + Blue Blink * N every 10 seconds</p>	<p>Multiple (N) valid Bluetooth connections have been established.</p>

## Cellular LED



The Cellular LED display the status of the internal cellular module.

Table 3-6 describes the LED colors and the patterns for the cellular module.

**Table 3-6. Cellular LED Descriptions**

Display	LED Color	Description
	No Light	There is no internal cellular module or it is switched off
	Green Solid	Cellular module is on and waiting for connection
	Green Blink	The connection has been established

## Radio LED







The Radio LED displays the status of the UHF modem.

Table 3-7 describes the LED colors and patterns for the UHF modem.

**Table 3-7. UHF Modem LED Descriptions**

Display	LED Color	Description
<b>Command mode (Rover and Base)</b>		
 	Red Blink - Green Blink - No Light	MAGNET Field or SRU sends commands to configure the modem.
<b>Receiver mode (Rover)</b>		

**Table 3-7. UHF Modem LED Descriptions (Continued)**

Display	LED Color	Description
	Green Solid	Modem is not receiving correction data.
	Yellow Blink	Modem is receiving correction data from a base.
<b>Transmitter mode (Base)</b>		
	Green Solid	Modem is not transmitting correction data.
	Red Blink	Modem is transmitting correction data.
<b>Retranslator mode (Base)</b>		
	Yellow Blink - Red Blink	Modem is receiving and transmitting correction data.



# Battery LED



The battery LED indicates the remaining charge of the internal battery. When using an external power source, the LED turns solid green and begins to blink if the internal battery is charging. See Table 3-8 for more information.

**Table 3-8. Internal Battery LED Descriptions**











Display	LED Color	Description
<b>The receiver is on—and the internal battery is in use</b>		
	Green Solid	The charge is greater than 50%.
	Yellow Solid	The charge is between 10% and 50%.
	Red Solid	The charge is less than 10%.
<b>The receiver is on—and the external power source in use</b>		
	Green Solid	The internal battery is fully charged.
	Green Blink	The internal battery is at greater than 50% capacity; the battery is charging.
	Yellow Blink	The internal battery is at greater than 10% capacity; the battery is charging.
	Red Blink	The internal battery is at less than 10% capacity; the battery is charging.

Table 3-8. Internal Battery LED Descriptions (Continued)

Display	LED Color	Description
<b>The receiver is off</b>		
	Green Solid	The receiver is connected to an external power source and the battery is fully charged.
	Green Blink	The receiver is connected to an external power source; the battery is charging.
	No Light	The receiver is not connected to an external power source.

# Managing Power

This chapter describes how to power the receiver, charge the battery and use an external power source.

## Turning the Receiver On/Off

To turn on the receiver, press and hold the power button until the STAT LED turns solid green. The receiver is turning on when: the Power LED blinks green, the receiver channels initialize and start tracking all visible satellites at any time and location and the serial port is available. When the startup is complete, the Power LED is solid green only when external power is used; otherwise the Power LED is off.

After startup, the integrated wireless devices in the receiver are ready to use and the receiver is available to obtain the correction data from reference station and to measure ground point coordinates with high accuracy. Also the receiver is ready to start data recording to the internal memory.

To turn-off the receiver, press and hold the power button for more than (3 but less than 10) seconds. Release the power button when the Power LED blinks yellow. This delay prevents the receiver from being turned off by mistake. Allow the receiver to complete the power off cycle, which is approximately 15 seconds.



### NOTE

The receiver will draw a small amount of power from the battery when it is turned off. If the receiver is placed in storage for a long period, 3-6 months, the battery may become fully discharged. Use an external power supply or recharge the battery before use.

---

## Powering the Receiver

The receiver is powered by an internal battery or an external valid power source connected to the power port. If an external power source is connected, the receiver draws power from it instead of the battery. You can connect the receiver to an external power source, such as a vehicle battery, with 9 – 27 VDC to operate the receiver. See “Specifications” on page 9-1 for more information.

See “Charging the Battery” on page 4-3 for more information.

---



### CAUTION

A power input greater than 27 VDC could damage the receiver.

---

## Operating Hours

Table 4-1 describes the use conditions and the operating hours of the receiver. The values in the **Approximate Hours of Operation** column are obtained when using the internal battery.

**Table 4-1. GRX3 Approximate Hours of Operation**

Use Condition	Description	Approximate Hours of Operation <sup>a</sup>
Static Survey	Static setup logging raw GNSS data at 1-Hz	15 hours
SiteComm RTK Base	Base transmitting RTCM3 differential corrections to one or multiple rovers (up to three rovers)	15 hours
SiteComm RTK Rover	Rover receiving RTCM3 differential corrections over SiteComm connected through Bluetooth to a data collector	15 hours
Network RTK Rover	Rover receiving RTCM3 differential corrections from a Network correction service and connected through Bluetooth to a data collector	13 hours
Network RTK Rover	Rover receiving RTCM3 differential corrections from a Network correction service via the internal cell module	12 hours
UHF Receive Only Mode	Rover receiving RTCM3 differential corrections over UHF radio connected through Bluetooth to a data collector	10 hours
UHF Transmitting at 0.5 W	Base transmitting RTCM3 differential corrections at 0.5 Watts	8 hours
UHF Transmitting at 1 W	Base transmitting RTCM3 differential corrections at 1-Watt	6 hours
UHF Repeater at 1-Watt	Receiving RTCM3 corrections and transmitting RTCM3 differential corrections at 1-Watt	6 hours
UHF Receiver + SiteComm Base	Receiving RTCM3 corrections over UHF radio and transmitting RTCM3 differential corrections over SiteComm	10 hours

a. Average with Bluetooth on and 20 Satellites tracked. Using a new, fully-charged battery, operating at room temperature and transmitting at 1-Hz rate.

# Charging the Battery

While the battery loses charge, the BAT LED changes from solid green, to yellow and then red, depending on the remaining charge (see “Battery LED” on page 3-8).

When the receiver is connected to an external power source, the internal battery is charging, regardless of the receiver state.

To charge the internal battery:

1. Connect the supplied power cable to the receiver’s power port.
2. Connect the SAE connector of the power cable to the SAE connector of the power adapter.
3. Plug the power adapter into an available outlet for approximately five hours to fully charge the battery.

Overcharging the battery will not happen; the battery stops charging when it reaches full charge. During charging, the BAT LED will blink (see Table 3-8 on page 3-8).



## CAUTION

Use a grounded wall outlet or grounded surge protector while charging. The socket should be located near the equipment and easily accessible.

## Battery Charging Temperatures

Charge the battery only in temperatures between 32° F (0° C) and 104° F (40° C).

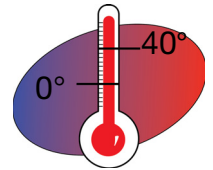

An optimal charging temperature is between 50° F (10° C) and 77° F (25° C). If possible, charge the battery within this temperature range.

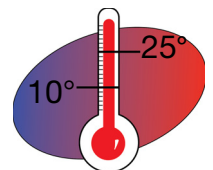

## CAUTION

The charge terminates automatically if battery temperature rises above 113° F (45° C) or falls below 32° F (0° C).

## Surveying While Charging

The receiver can perform any kind of surveying while charging the internal battery without degrading performance.



## CAUTION

While charging, make sure that the air temperature is between 32° F (0° C) and 104° F (40° C). This is important to prevent serious damage to the external power supply adapter, battery, and the receiver or injury to persons.

# Using an External Power Source

You can connect the receiver to an external power source (such as a vehicle battery with 9 – 27 VDC) to operate the receiver.

**CAUTION**

Power input greater than 27 VDC could damage the receiver.

---

To connect the receiver to an external battery:

1. Use the ODU-to-alligator clips cable (P/N 14-008097-01LF) to directly connect the external battery and the receiver's power port (without SAE).
2. Connect the ODU-to-alligator clips cable to a 12-volt battery.
3. Connect the ODU-to-alligator clips cable to the receiver's power port.
4. Turn on the receiver.

## Insufficient Power

If the battery become fully discharged and an external power supply is not connected, the receiver will shut down and automatically save recorded files. To avoid disruptions, check the BAT LED on the display panel for the battery charge status. See, "Battery LED" on page 3-8 for more information. If the receiver shuts down due to insufficient power, the receiver and all communication ports become deactivated.

To restore power to the receiver you will need to connect the receiver to an external power source:

- a. Make sure the power cable is correctly connected to the power port of the receiver.
- b. Align the keyways when connecting the power cable to the power port of the receiver.
- c. The cable will click when it is secured in the port.
- d. To remove the cable, push the cable in, then gently remove it from the power port.

**NOTICE**

Recharge the battery or connect it to an external power source using the charging cables and power adapter shipped with the receiver. The time to fully charge the battery at 77 degrees F (25 degrees C) is about 5 hours.

---

# Configuration

The GRX3 receiver is primarily used for surveying land and construction job sites and to support static and RTK applications. You can also log data internally to a non-removable SD card. These logs can be downloaded from the receiver for static or kinematic surveying, mapping, monitoring and positioning applications. The receiver uses different built-in communication technologies to transmit or receive RTK corrections and to achieve RTK solutions using field applications like MAGNET Field or Pocket 3D.

The receiver can be configured in a variety of ways, depending on your project requirements. Typically, the receiver supports the following operation modes:

- Static and kinematic post-processing
- Network RTK rover as NTRIP client
- UHF base and rover in RTK or DGPS configuration (for receiver with UHF modem)
- SiteComm base and rover in RTK or DGPS configuration
- UHF modem repeater (for receiver with UHF modem)
- DGPS or RTK repeater
- Precise Point Positioning (PPP) rover
- SBAS rover

This chapter describes: receiver configuration, receiver options, loading a new Option Authorization File (OAF), updating firmware and performing a factory reset. All these actions may be performed using Sokkia Receiver Utility (SRU) software.

## Installing Sokkia Receiver Utility (SRU)

SRU is a Microsoft Windows software application designed for configuring GNSS receivers, modem boards and Bluetooth modules. This software is available on Sokkia Care for registered users. After downloading the program from the website, copy the \*.zip file into folder on hard drive of controller or computer.

1. Navigate to the folder and extract the SRU\*.zip file.
2. Double-click SRU\*.exe to run the installer and then follow the on-screen instructions.



**NOTE** To uninstall SRU, use Add or Remove Programs in Microsoft Windows.

---

# Loading New Firmware

This section of the configuration chapter describes how to update firmware on the GRX3 with a USB connection. To connect the receiver to your computer, use a Micro-USB cable (P/N 1013602-01) and USB drivers installed on the computer. USB drivers and firmware are available at Sokkia Care.

After plugging the receiver into to the computer, the operating system will report a new external device has been found. It will be assigned to a virtual COM port. You may check its number in the Windows **Device Manager** (Figure 5-1).

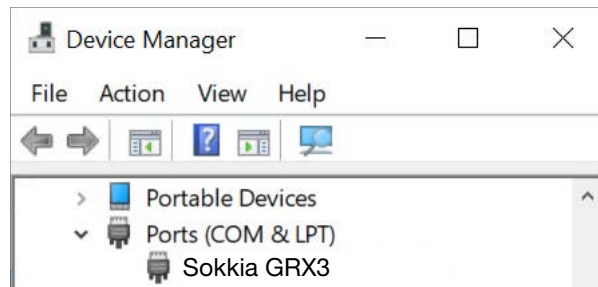

**Figure 5-1: Device Manager Screen**

This virtual port is used for loading new firmware. You can also update the firmware using a physical COM port or Bluetooth. Loading firmware using a physical COM port takes longer than using SRU. Therefore, Sokkia does not recommend using a physical COM port to update firmware.

Receiver board firmware is released as a file with “\*.tfl” extension. Sokkia Receiver Utility version 3.6 and higher supports loading of files with “\*.tar” and “\*.tfl” extensions.

To upload firmware files to the receiver, do the following:

1. Connect the receiver to a computer using a Micro-USB cable (Figure 5-2).



**Figure 5-2: Micro-USB Cable Connection**

2. In the Windows **Device Manager**, check the number of the virtual COM port.
3. Start SRU on your computer.



4. Use the **Safely Remove Hardware and Eject Media** feature in Windows and mount the receiver in SRU. For details, see “Ejecting the Receiver from Windows and Mounting in SRU” on page 7-8.
5. Click **Device > Application Mode > Firmware Loading**, to set SRU to the firmware loading mode.
6. Click **Device > Connect**.

The **Connection Parameters** screen opens.

7. Select **Serial Port** from the **Connect Using** drop down list.
8. Click the  button.

The **Select Device** screen opens (Figure 5-3).

9. Select the *specified COMX* port for USB communication and then click **OK**.

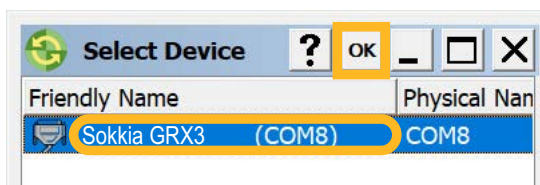

**Figure 5-3: SRU—Select Device Screen**

The **Connection Parameters** screen opens (Figure 5-4).

10. Click **Connect** to establish a connection with the receiver.

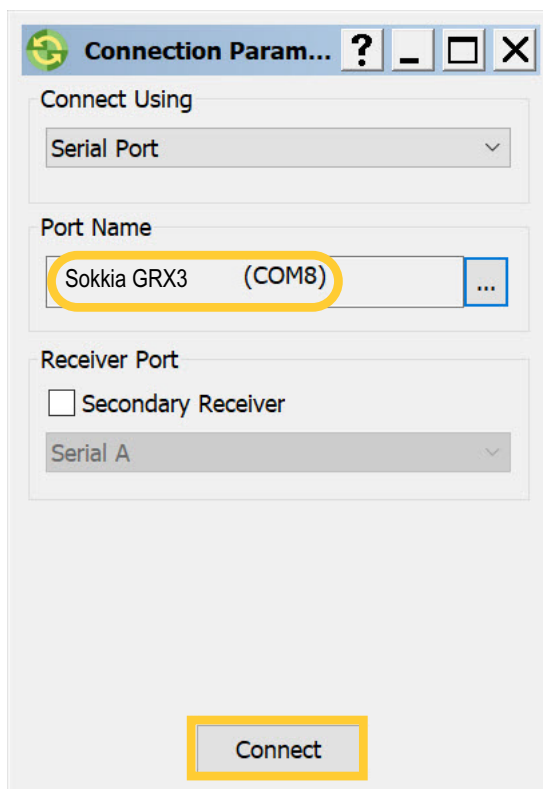

**Figure 5-4: SRU—Connection Parameters**

The **Firmware Loading** screen opens.

11. Click **Firmware Loading**  .

The **Select Target** screen opens (Figure 5-5 on page 5-4).

12. Select **Receiver** from the **Target** drop-down list (Figure 5-5 on page 5-4).
13. Click **Next**.

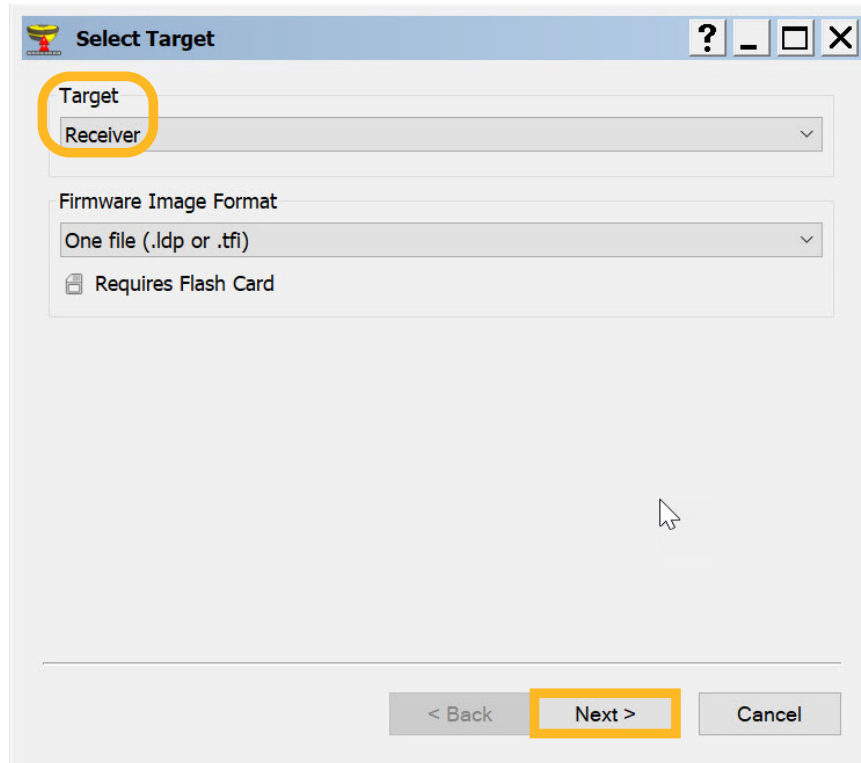

**Figure 5-5: SRU—Select Target**

The **Information** screen opens (Figure 5-6).

14. Click **Next**.

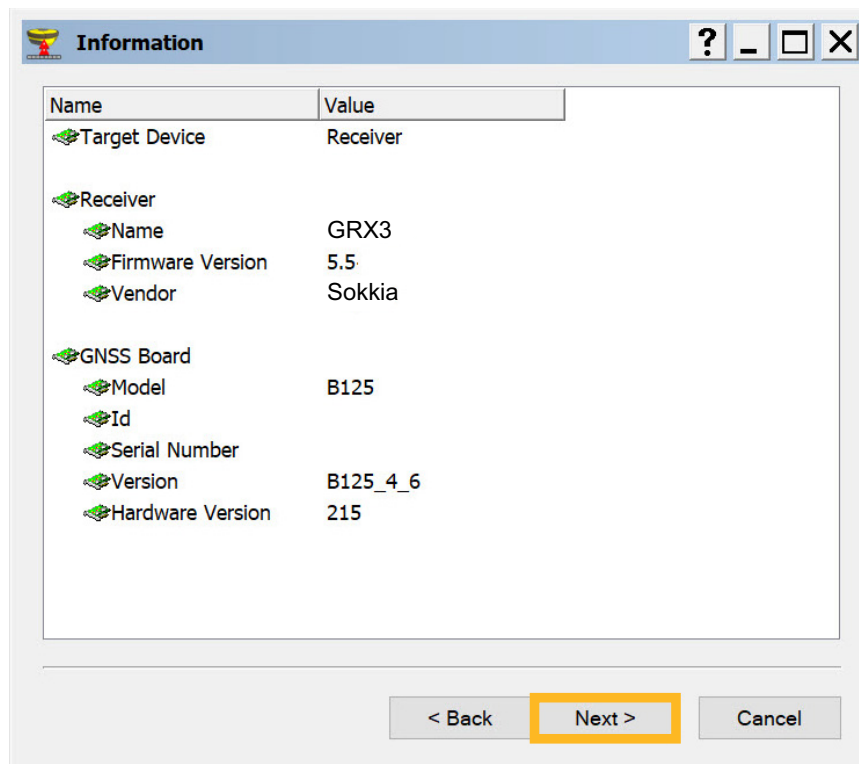
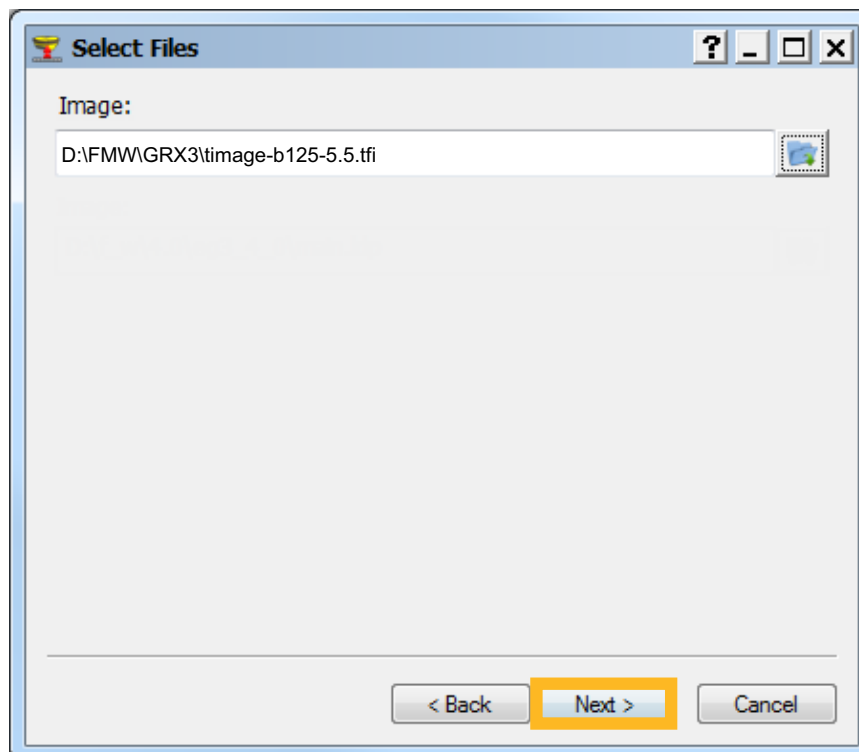

**Figure 5-6: SRU—Device Information Screen**

The **Select Files** screen appears (Figure 5-7 on page 5-5).

15. Click the  button, browse to, and select the receiver's \*.tff file.

16. Click **Next**.



**Figure 5-7: SRU—Select Files**

The **Installation** screen opens (Figure 5-8). It shows the progress as the firmware uploads.

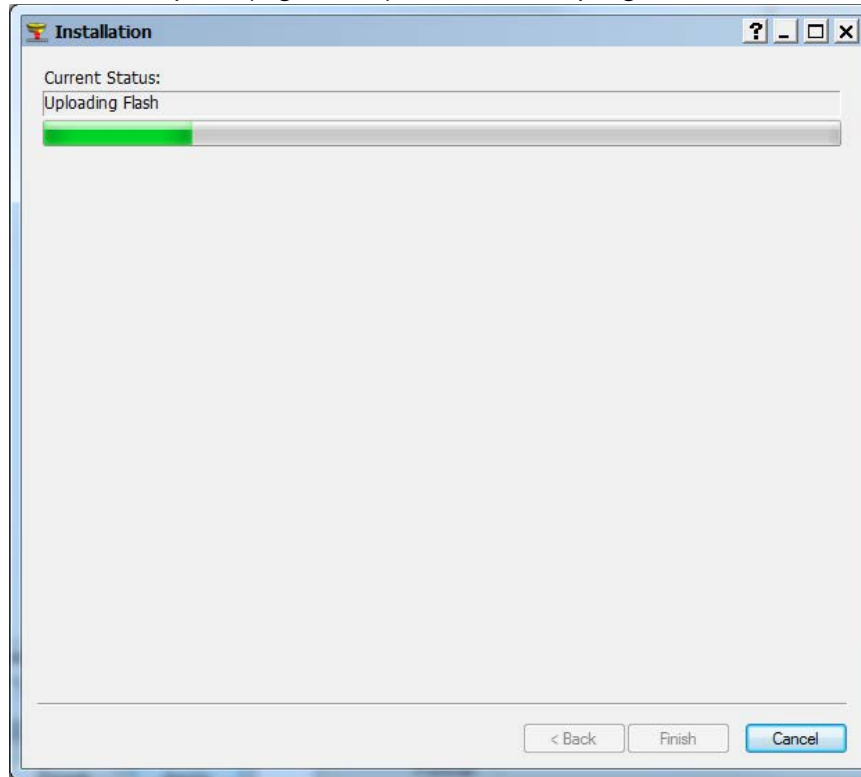

**Figure 5-8: SRU—Installation Screen**

When the firmware completes uploading, a dialog window opens (Figure 5-9 on page 5-6). It warns not to turn off the receiver while it updates the firmware.

17. Click **OK** in the dialog box.

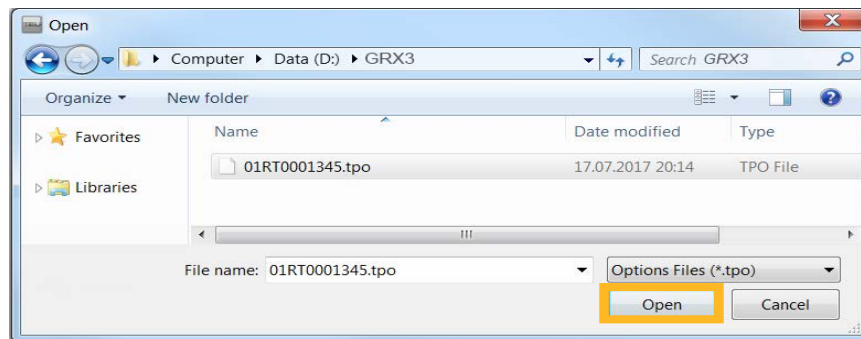

**Figure 5-9: SRU—Firmware Updating Window**

SRU automatically disconnects from the receiver. The receiver reboots a few times during the firmware update.

The firmware update may take up to 10 minutes. After the firmware update completes, the receiver returns to the normal operation mode.



**NOTE**

The procedure for loading new firmware into the GRX3 can be performed using MAGNET Field software version 5.1 and higher.

# Option Authorization Files

Sokkia's issues an Option Authorization File (OAF) to enable the specific options that you purchased. Sokkia's OAF system allows you to customize and configure the receiver according to your particular requirements.

The GRX3 receiver is typically shipped with an OAF based on the initial purchase of the receiver kit configuration. There are several upgrade options available with the receiver that can extend the receiver's functionality to better suit your job requirements. Examples of upgrade options are listed below:

- GPS L1, L2, L5 signal tracking
- GLONASS L1, L2, L3 signal tracking
- BeiDou B1, B2 signal tracking
- QZSS L1, L2, L5 signal tracking
- SBAS L1, L5 signal tracking
- Galileo E1, E5 signal tracking
- RTK and update rate 20 Hz (10 Hz standard)
- Precise Point Positioning (PPP) Mode

Contact your Sokkia dealer or a customer representative for a complete listing of available options and pricing information.

## Checking the Receiver's OAF

1. Connect the receiver to a computer and open SRU.
2. Start SRU on your computer.
3. Click **Device > Application Mode > Receiver Managing**.
4. Click **Device > Connect**.

The **Connection Parameters** screen opens.

5. Click the **Connect** button to establish a connection with the receiver.
6. Click **Options**  on the main screen.

The **Receiver Options** window opens (Figure 5-10). Here you can view the current authorization options and upload new ones.

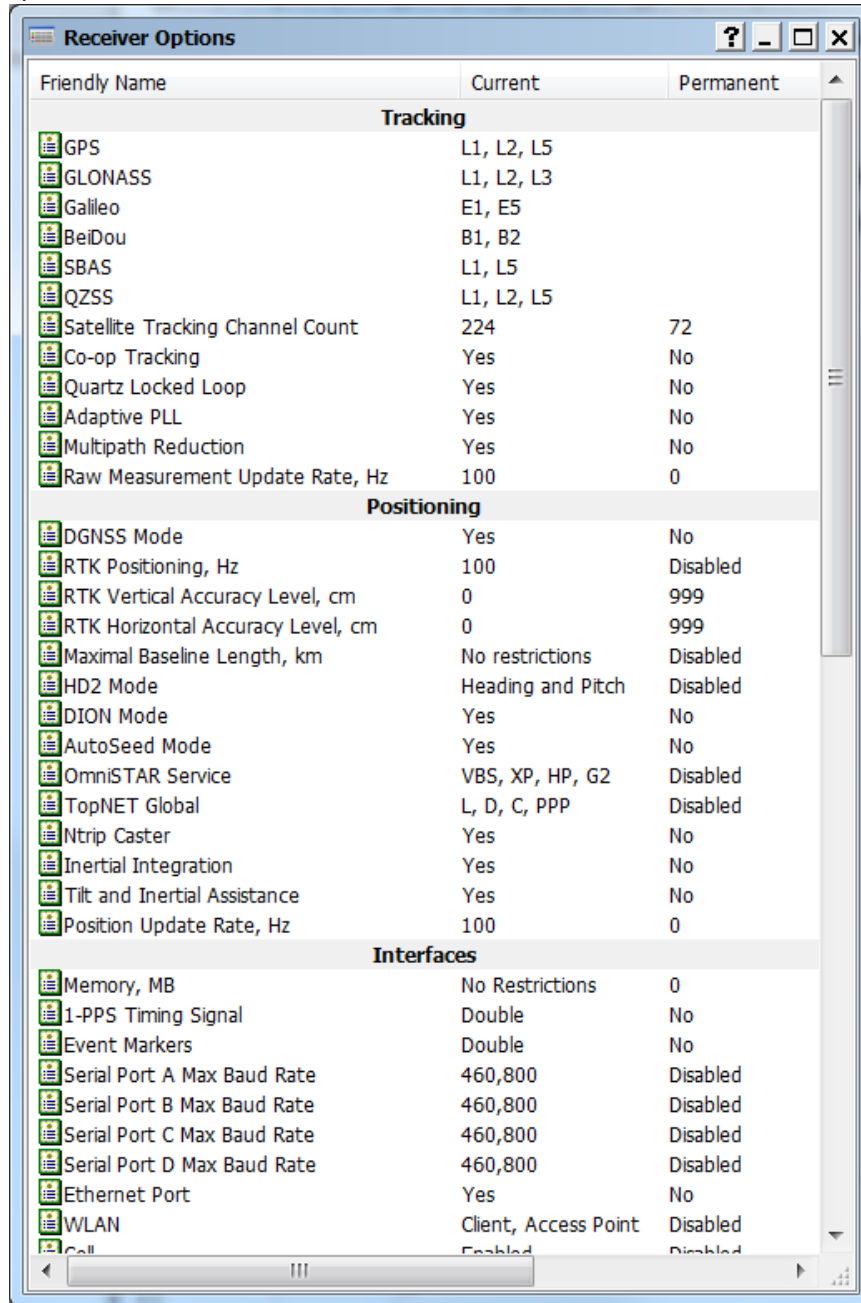
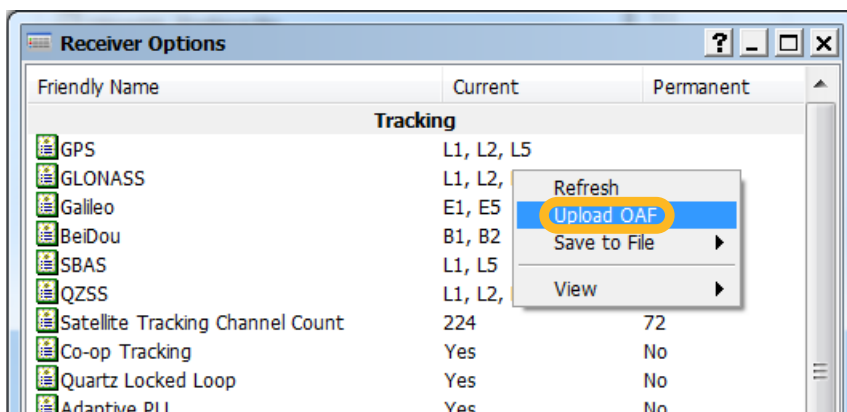

**Figure 5-10: SRU—Receiver Options**

## Loading an OAF

Sokkia dealers provide customers with OAF files. For any OAF related questions, e-mail Sokkia at [options@topcon.com](mailto:options@topcon.com) and include the receiver's ID and serial number. To obtain these numbers, see "Getting Technical Support" on page 1-4.

1. Complete the steps in "Checking the Receiver's OAF" on page 5-7 above.
2. Right click on the **Receiver Options** window and select **Upload OAF** (Figure 5-11).



**Figure 5-11: Right-click and Select Upload OAF**

3. Navigate to the location of the new Option Authorization File.
4. Select the appropriate file and click **Open** (Figure 5-12).

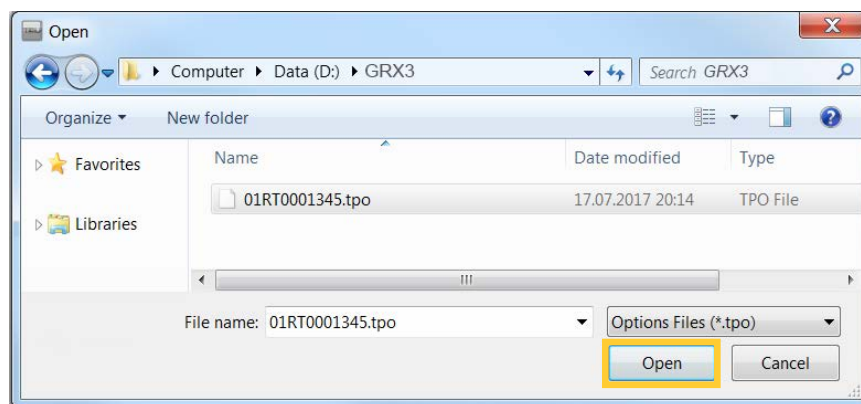

**Figure 5-12: Open OAF**



### NOTE

SRU initially checks to see if the selected file is compatible with the currently connected receiver. If you chose a file that is not intended for this receiver, the **Upload OAF** window will display an error icon next to the **Receiver ID** (not shown) and disables the **Upload the File to the Receiver** button (Figure 5-13 on page 5-10).

- Click **Upload the File to the Receiver** to start loading the file (Figure 5-13).

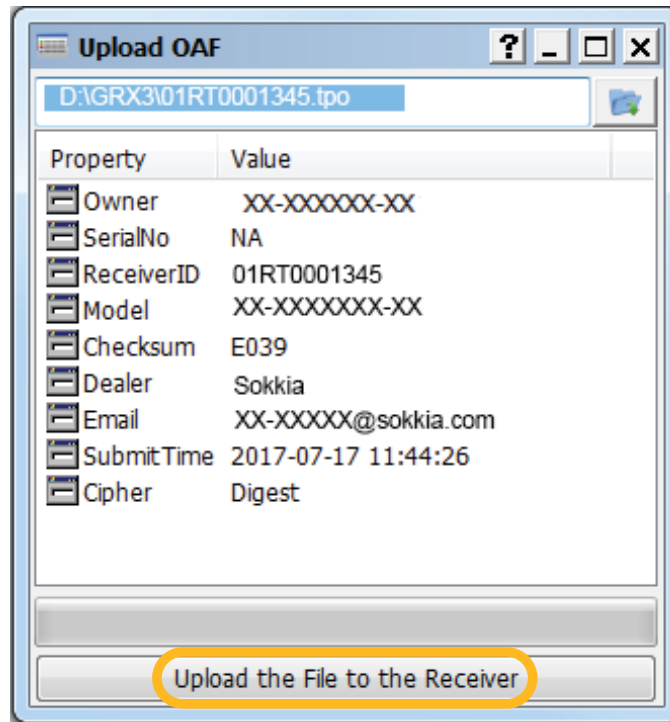

**Figure 5-13: Upload OAF to the Receiver**

- Click **Yes** at the prompt to reset the receiver (Figure 5-14).

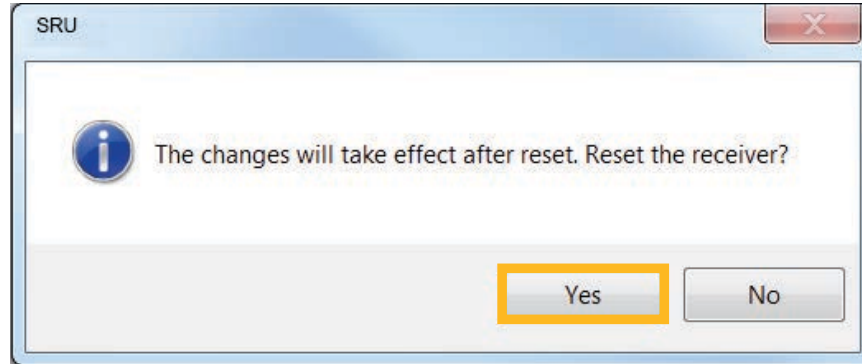

**Figure 5-14: Reset Receiver**

The **Connection Parameters** screen opens.

- Click **Connect** on the **Connection Parameters** screen.

The SRU main screen opens.

- Click **Options** .

The **Receiver Options** screen opens.



9. Check the following conditions:
  - If you uploaded a universal OAF, make sure the expiration date is still valid.
  - If you uploaded a customer OAF, make sure the correct customer file is loaded.
10. To view additional OAF details, right click in the **Receiver Options** window and select **View > Detailed** (Figure 5-15).

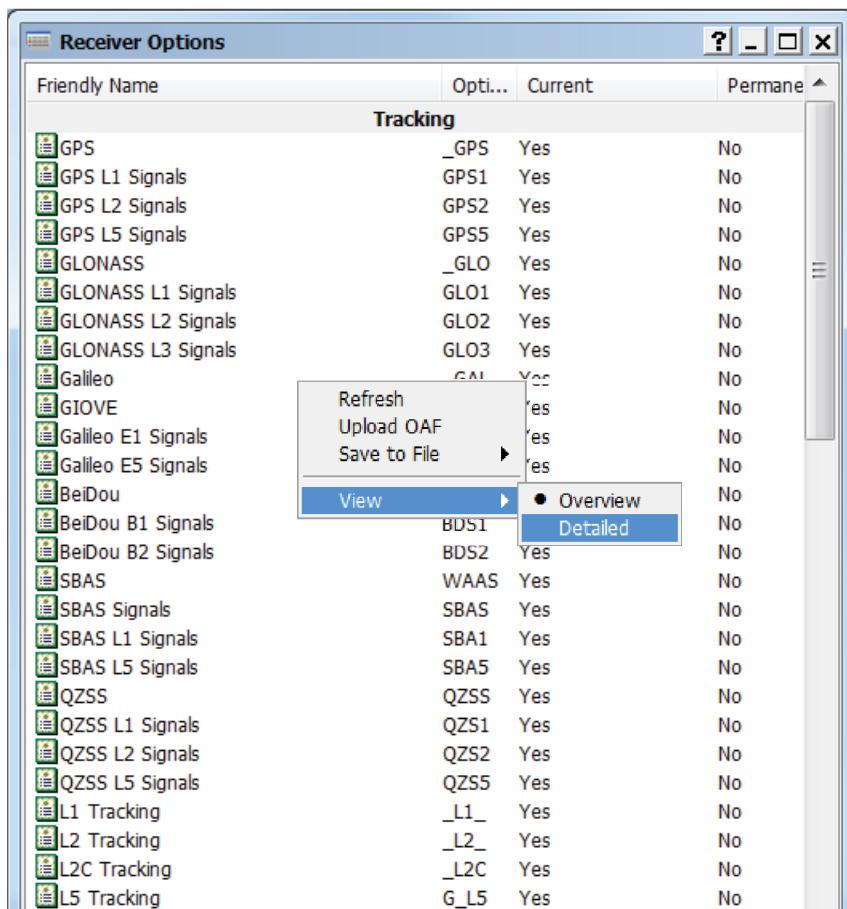

**Figure 5-15: Additional OAF Details**



**NOTE**

The procedure for loading new firmware into the GRX3 can be performed using MAGNET Field software version 5.1 and higher.

# Performing a Factory Reset

The receiver's Non-Volatile Random Access Memory (NVRAM) holds data required for satellite tracking, such as ephemeris data and receiver position. The NVRAM also keeps the current receiver's settings, such as active antenna input, elevation masks and recording interval and information about the receiver's internal file system. A factory reset clears the receiver's NVRAM and restores the receiver's factory default settings. Factory reset takes about 1-2 minutes to perform.

Although a factory reset or clearing the NVRAM is not recommended as a common practice, there are times when it can eliminate communication or tracking problems.

After a factory reset, the receiver requires time to collect new ephemeris data and almanacs (approximately 15 minutes).

A factory reset will not delete any files already recorded in the receiver's memory and NVRAM keeps information about the receiver file system.

There are two ways you can perform a factory reset—using SRU software and using the LED display panel.

## Perform a Factory Reset Using SRU

1. Connect the receiver to a computer.
2. Start SRU on your computer.
3. Click **Device > Application Mode > Receiver Managing**.
4. Click **Device > Connect**.

The **Connection Parameters** screen appears.

5. Click the **Connect** button to establish a connection with the receiver.
6. Click **Tools**  on the main screen.

The **Tools** screen opens (Figure 5-16 on page 5-13).

- Click **Factory Reset**.

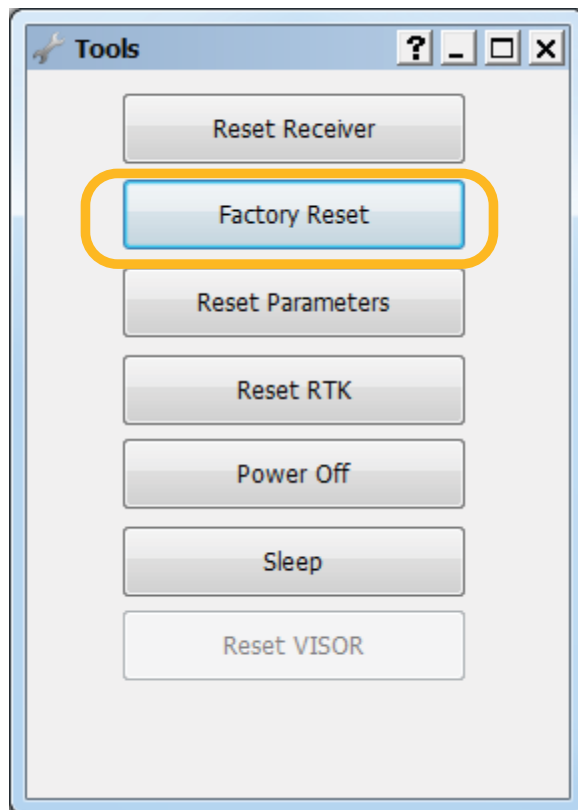

**Figure 5-16: Tools Screen**

- Click **Yes** at the prompt to reset the receiver.

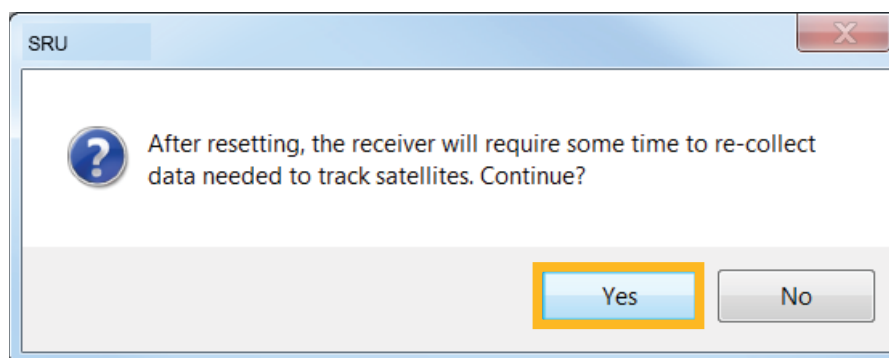

**Figure 5-17: Reset Receiver**

SRU resets the receiver and clears the NVRAM.

## Perform a Factory Reset Using the LED Display

- Press and hold the Power button for 30–35 seconds. Release it when STAT LED turns red.
- Wait until the STAT LED blinks yellow.  
The receiver automatically powers off.
- Wait until the Power LED stops blinking green.

The receiver automatically powers on.

# Using TILT Correction

The receiver contains the internal HIMU (Hybrid Inertial Measurement Unit) module. The module includes a 3D gyroscope, 3D accelerometer, and 3D magnetometer.

GNSS firmware of the GRX3 contains the ELC (Electronic Level and Compass) program module. This module uses the measured parameters from the HIMU, receiver navigation coordinates from the GNSS firmware and magnetic field map for calculation of tilt angles in the horizontal plane, and true (not magnetic) azimuth and magnetic field values. Using these data, GRX3 solves the following tasks:

1. It calculates the tilt angle of the pole and transmits the value to the field software. The software will calculate the true coordinate of the measured ground point. You can activate this mode using MAGNET Field (version 5.1 and higher). For the **Topo**, **Autotopo**, and **Stake** survey, MAGNET Field uses the tilt angle of the pole from the ELC module to calculate the offset of the GNSS antenna phase center in the horizontal plane, for each GNSS epoch. These offset values are used for obtaining the true coordinates of the measured ground point. This mode will work if the current tilt angle does not exceed the threshold value. A user can specify this value in the range from 1 to 15 degrees.

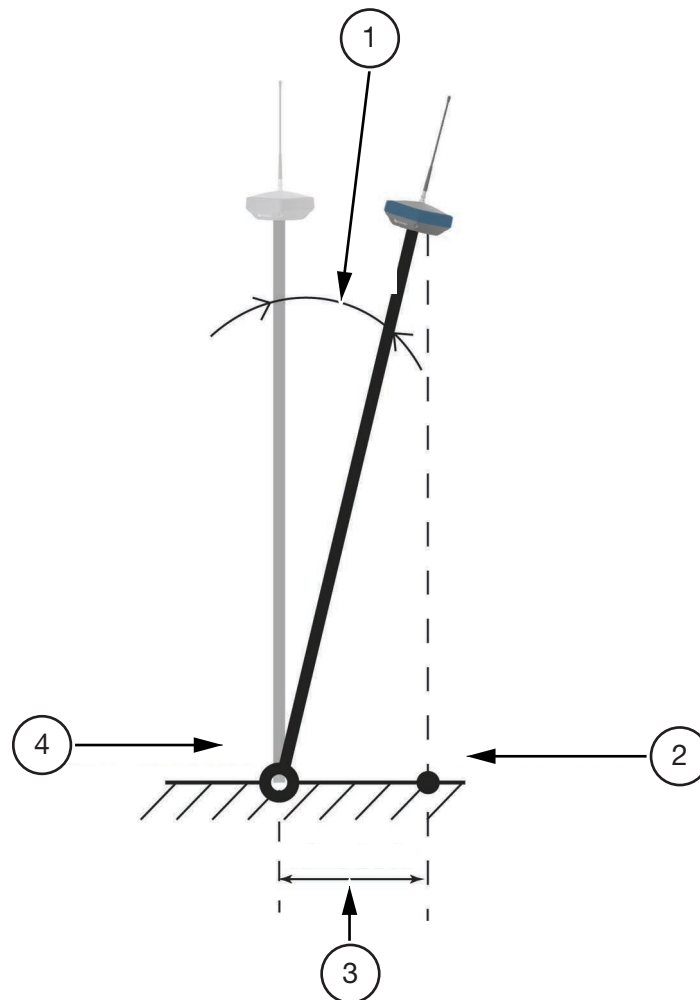

- |   |  |
|---|--|
| 1. Tilt pole angle                      | 3. Offset dN/dE                        |
| 2. False projection of the phase center | 4. True projection of the phase center |

**Figure 5-18: Tilt Correction Mode**

2. It automatically starts the measuring of a point if the pole tilt value is less than 1 degree during the time interval longer than the **specified** value.
3. It shows/hides a graphic view of the bubble level. MAGNET Field shows the bubble level in the **Topo**, **Autotopo**, and **Stake** dialogs for GNSS configuration only.

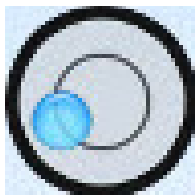

**Figure 5-19: Bubble Level**

4. Shows/hides the value of the external magnetic field in the graphic and text view in the **Topo**, **Autotopo**, and **Stake** mode.

## HIMU Calibration

The internal HIMU provides 3-axis monitoring of the earth's magnetic field to deliver azimuth data. Due to e-compass parameters used in this technology, a simple field calibration procedure is required. Using MAGNET Field or SRU, you can perform the electronic level and the compass calibration procedure.

The calibration consists of the following procedures:

1. Electronic level calibration (see “Level Calibration” on page 5-16)
2. Magnetic compass calibration in 3D (see “3D Compass Calibration” on page 5-17)
3. Magnetic compass calibration in the horizontal plane (see “Horizontal Plane Compass Calibration” on page 5-18)

Perform each calibration procedure independently and sequentially. When all three calibrations are finished, the HIMU is ready to use.

Follow these general recommendations when performing the ELC calibration:

- Perform the calibration in the field, after that the receiver tracks the satellites and determines a position.
- Establish the connection with a controller via Bluetooth or Wi-Fi.
- Turn on and/or connect all equipment that will be used for the survey, before calibrating.
- For RTK survey, use your choice of modem to receive the corrections data and obtain the Fixed solution.
- If using the UHF modem, connect the radio antenna and turn on the radio modem.
- Do not use an external power source.

You can use MAGNET Field or SRU to calibrate the ELC module of the GRX3 receiver.

## Level Calibration

To take an accurate level and compass reading, first you need to perform the electronic level calibration procedure.

Do the following:

1. Set up the receiver on a tripod with a universal tribrach and tribrach adapter:
  - Level the tribrach.
  - Set the receiver on a tribrach adapter with a 100 mm aluminum prism spacer.
  - Eliminate any vibrations during the calibration.

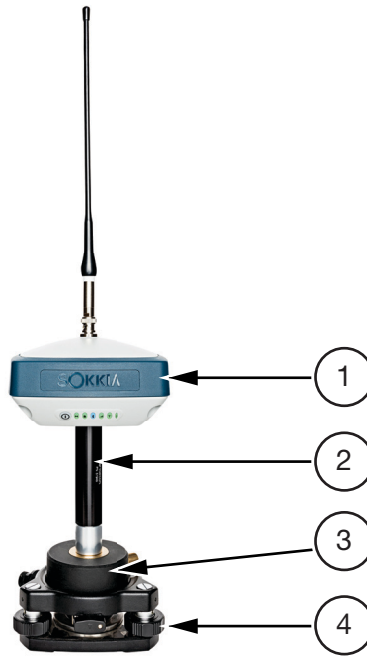

- |                        |                              |
|------------------------|------------------------------|
| 1. GRX3                | 3. Rotating tribrach adapter |
| 2. 100 mm prism spacer | 4. Tribrach                  |

**Figure 5-20: Receiver and Tribrach Set Up**

The receiver tracks satellites and determines a position.

2. In MAGNET Field/SRU, click **Calibrate** in the **Level** field.

The calibration process starts. It takes about 30 seconds to complete.

- If the calibration succeeds, the **Level** field shows the date and time for the new calibration.
- If the calibration fails, the **Level** field shows the date and time for the previous successful calibration with the  icon.

## 3D Compass Calibration

To take an accurate compass reading, first you need to perform the compass calibration procedure for each location in 3D, before starting a survey.



### NOTICE

Be sure to calibrate the level (see “Level Calibration” on page 5-16), before calibrating the compass.

Do the following:

1. Hold the receiver flat with the GNSS antenna randomly pointed up.
2. Press the **Calibrate Compass** button.
3. Rotate the receiver 360 degrees in multiple planes and directions. The position of the receiver’s antenna’s phase center should fill an entire sphere around the receiver.

MAGNET Field/SRU shows a progress bar reflecting your progress with filling the sphere around the receiver. It shows, “*Compass is being calibrated,*” (Figure 5-21).

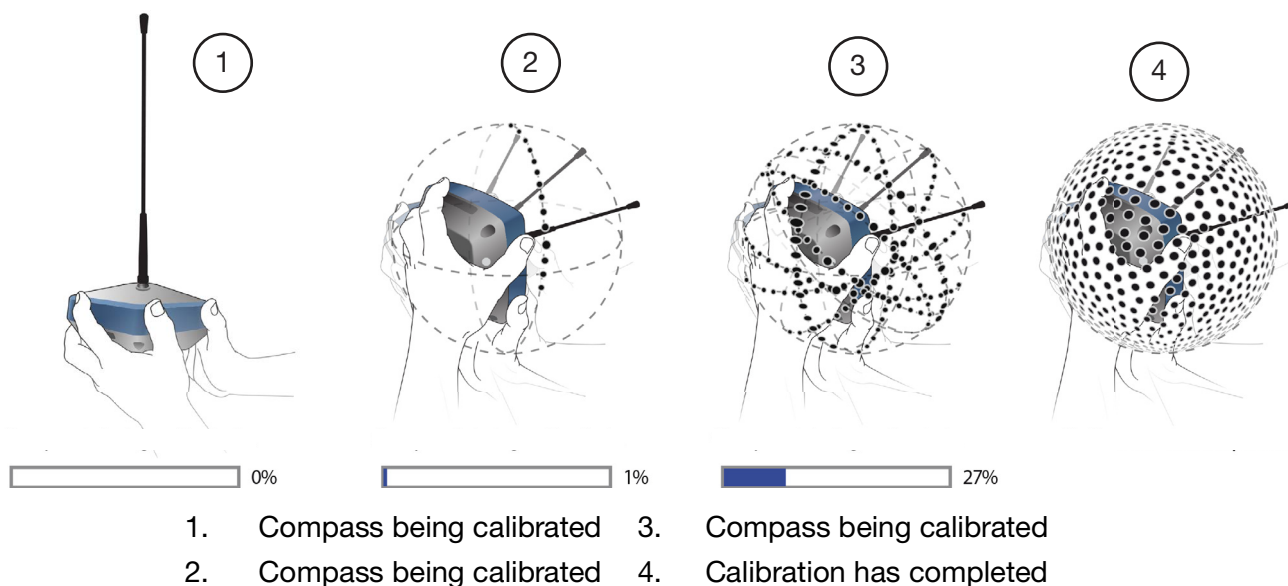

**Figure 5-21: Calibrating the Compass in 3D**

- If you have successfully filled the entire sphere, MAGNET Field/SRU shows, “*Calibration has completed,*” (Figure 5-21).

The calibration parameters are saved. The receiver’s compass is ready to use.

- If you stop rotating the receiver before the calibration procedure is complete, after two minutes of leaving the receiver still, without movement, MAGNET Field/SRU shows, “*Calibration has failed.*”

Perform the procedure again until you have successfully filled the entire sphere.



### NOTE

The calibration is saved when you turn the receiver power off. The saved calibration is used the next time you turn the receiver power on.

## Horizontal Plane Compass Calibration

To take an accurate compass reading, you need to perform the compass calibration procedure in the 2D, horizontal plane for each location, before starting a survey.



### NOTICE

Be sure to calibrate the level first (see “Level Calibration” on page 5-16), then calibrate the compass in 3D next (see “3D Compass Calibration” on page 5-17), before calibrating the compass in the 2D, horizontal plane.

Do the following:

1. Set up the receiver on a tripod with a universal tribrach and tribrach adapter:
  - Level the tribrach.
  - Set the receiver on a tribrach adapter with a 100 mm aluminum prism spacer.
  - Set the receiver at a 90-degree angle to the horizontal plane to maximize the accuracy of the calibration.
  - Eliminate any vibrations during the calibration.

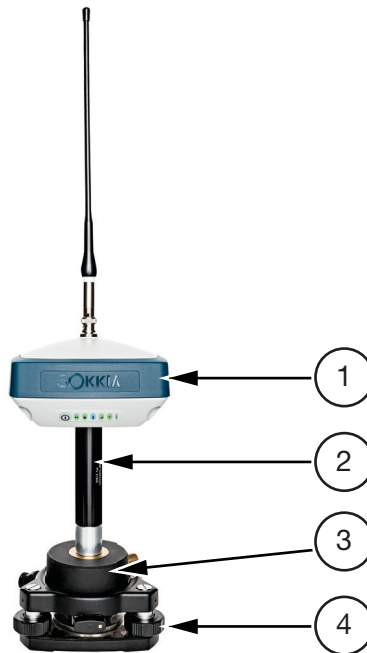

- |                        |                              |
|------------------------|------------------------------|
| 1. GRX3                | 3. Rotating tribrach adapter |
| 2. 100 mm prism spacer | 4. Tribrach                  |

**Figure 5-22: Receiver and Tribrach Set Up**

The receiver tracks satellites and determines a position.

2. In MAGNET Field/SRU, click **Calibrate** in the **Level** field.
3. Turn the receiver clockwise in the horizontal plane.

MAGNET Field/SRU shows a progress bar reflecting how many turns are left to complete the calibration.



- If you do not make any turns for two minutes, the calibration routine automatically stops.

Perform the procedure again until you have successfully filled the entire sphere.

- If you successfully complete all of the turns, MAGNET Field/SRU shows, “*Calibration has completed.*”

The calibration parameters are saved. The receiver is ready to use.

- If you do not successfully complete all of the turns, MAGNET Field/SRU shows, “*Calibration has failed.*”

Perform the procedure again until you have successfully filled the entire sphere.

**NOTE**

The calibration is saved when you turn the receiver power off. The saved calibration is used the next time you turn the receiver power on.

---

## When Compass Recalibration is Required

During operation, the receiver evaluates the local magnetic environment and alerts a user if a recalibration is required. These alerts appear in the field software. Make sure to recalibrate the receiver when the field software indicates. Also recalibrate the receiver under the following conditions:

- If the receiver has been off for a long time
- If the receiver is used for the first time
- If the survey location changes frequently
- If the receiver took a shock, such as being dropped
- If temperature changes are 10 degrees or more
- If the receiver was transported by a car or airplane
- If the receiver was near a strong magnetic object or material, such as a permanent magnet, electromagnet, electric transformer, AC power supply, and so forth
- After loading new firmware
- After clearing the NVRAM

# System Setup

The base receiver transmits RTK corrections to the rover receiver using either SiteComm wireless technology or UHF modem. The internal cell module receives correction data from reference GNSS networks.

This chapter describes the field setup for base or RTK rover usage.

## Setting Up the Base Receiver

1. Install a heavy-duty tripod (P/N 22-050501-01) over a known point (Figure 6-1).



### NOTE

You do not need a universal tribrach and tribrach adapter when working on this tripod.

---



**Figure 6-1: Setting Up Base Receiver**

2. Position the base receiver over a point with a known coordinate in the current coordinate system.

3. Attach the antenna to the UHF modem antenna connector.
4. Level the tripod and tighten the screws.
5. If needed, attach any other accessories, such as a back-up power supply.
6. Measure the height of the receiver from the ground using the tape measure. See “Measuring Antenna Height”.
7. Press the Power button to turn on the receiver. The integrated wireless device inside the receiver turns on when the receiver is powered.
8. Run MAGNET Field software on the field controller and connect the base receiver to the controller via Serial Port or Bluetooth. Select the following parameters:
  - Elevation mask
  - The RTK output format
  - Radio modem parameters (for UHF modem; Power, Protocol, Modulation, Spacing, Scrambling)
  - FEC for UHF modem; Power, Channel, Protocol)
  - Raw data logging, if it is required
9. Use MAGNET Field software:
  - Type in the name of the point where the Base receiver is located.
  - Enter the coordinates of this point.
  - Click the **Start Base** button to start the receiver as the Base transmitting the correction data.
10. View the LED display panel for the receiver’s current status. See “System Setup” on page 6-1 for more information about LEDs.

**NOTE**

Select RTCM MSM3 format in the RTK output protocol to create the correction data with measurements of GPS, GLONASS, BeiDou, Galileo, QZSS, and NavIC satellite systems.

# Setting Up the Rover Receiver

1. Attach the receiver to the pole. Make sure the receiver locks into place.



**Figure 6-2: Rover Receiver**

2. If you are not using a fixed height rover pole, measure the height of the receiver from the ground. See “Measuring Antenna Height” on page 6-6.
3. Attach the antenna to the **UHF modem** antenna connector if you are using a radio modem. If necessary, see “Receiver Enclosure Bottom—Connectors” on page 2-11.
4. If you are using a **cellular module** insert the SIM card into the SIM card slot. If necessary, see “Receiver Enclosure Bottom—Connectors” on page 2-11.



## NOTICE

If you are using a **cellular module** in Network RTK configuration, ensure that the cellular antenna is attached to the GRX3 receiver.

5. Press the Power button to turn on the receiver. The integrated wireless device inside the receiver turns on when the receiver is powered.
6. Run MAGNET Field software on the field controller and connect the rover receiver to the controller via Serial Port or Bluetooth.
7. Configure UHF modems or cellular modules:
  - Select for the receiver with the UHF or FH modems:
    - An elevation mask
    - The RTK input format
    - The radio modem parameters (for UHF modem; Power, Protocol, Modulation, Spacing, Scrambling, Channel, FEC)
    - The parameters of raw data logging, if it is required

- Select for the receiver with the cell module:
  - The type of correction data that will be used for survey (VRS or Single Base or MAGNET Relay)
  - The protocol of the input correction data: TCP/IP or NTRIP 2.0/1.0 or NTRIP 1.0
  - An elevation mask
  - The RTK output format
  - The Internet address and TCP port number of the remote server, a password and user ID to login to the selected server and configure parameters for a dial-up Internet connection
  - The parameters of raw data logging, if it is required
- 8. Click **Connect** icon on the main screen of the MAGNET Field and click the **Connect** button in the Connections screen to establish Internet connection to the remote server and obtain the correction data from it.
- 9. View the LED display panel for the receiver's current status. See "Display Panel" on page 3-1 for more information about LEDs.

# Using GRX3 with External Antenna

The GRX3 GNSS receiver can be used with an external antenna. The GRX3 receiver is primary designed for using with Sokkia active (with LNA) external antenna.



## CAUTION

Sokkia cannot guarantee the correct performance with other brands of GNSS antenna. Do not use passive GNSS antenna with the GRX3 receiver.

To work with an external GNSS antenna you have to manually set the external antenna type using MAGNET Field or SRU application.

- Using MAGNET Field:
  - a. Select **Configure > Application Mode**.
  - b. Open the **Config: Base Receiver** or **Config: Rover Receiver** dialog.

By default, the internal antenna of GRX3 is set for this receiver;

The screenshot shows the 'Base Receiver' configuration window in MAGNET Field. It includes a title bar with a green checkmark and a red X. The 'External Receiver' checkbox is checked. The 'Receiver Model' is set to 'GRX3'. The 'Serial Number' field is empty. The 'Elevation Mask' is set to '13 deg'. The 'RTK Format' is set to 'RTCM 3.x MSM3'. The 'Antenna' dropdown menu is open, showing 'GRX3' as the selected option.

**Figure 6-3: Configuration GRX3 with Internal Antenna in MAGNET Field**

- c. From the **Antenna** drop-down list, select a type of the base/rover receiver antenna used.

The screenshot shows the 'Base Receiver' configuration window in MAGNET Field, similar to Figure 6-3. The 'Antenna' dropdown menu is open, showing 'SA350 w/GP' as the selected option.

**Figure 6-4: Configuration GRX3 with External Antenna in MAGNET Field**

- d. Click  to save changes in the configuration wizard.

- e. Connect the external antenna to the External GNSS Antenna Connector using the External Antenna Cable (P/N 1006447-01).



**NOTE** After this change the receiver will track GNSS signals only with external antenna.

- Using SRU:
  - a. Select **Receiver Settings ▶ Tracking and Positioning**.

In the **Antenna** tab, the internal antenna of GRX3 is set for this receiver by default;

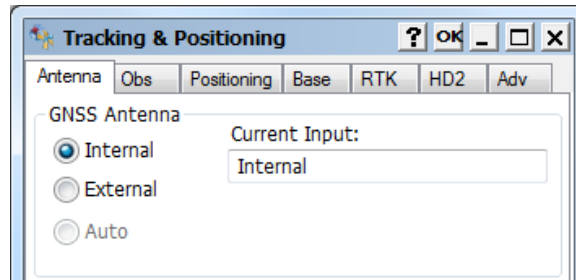

**Figure 6-5: Configuration GRX3 with Internal Antenna in SRU**

- b. Select the *External* radio button to activate an external type for GRX3 receiver. Click **OK** button to sent this change to the receiver:

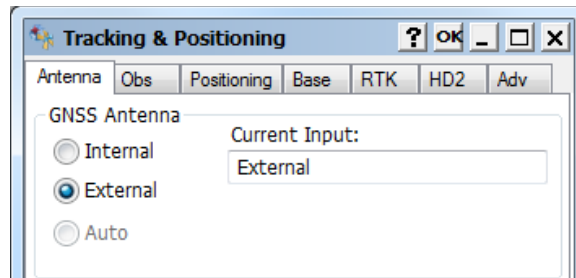

**Figure 6-6: Configuration GRX3 with External Antenna in SRU**

- c. Connect the external antenna to the External GNSS Antenna Connector using the External Antenna Cable (P/N 1006447-01).



**NOTE** After this change the receiver will track GNSS signals only with external antenna.

When the external antenna is selected, the GRX3 supplies a voltage in the range from +4.5 V to +5.5 V to the central pin of the SMB antenna connector. Maximum antenna current equals to 120 mA.

## Measuring Antenna Height

The receiver calculates the coordinates of the antenna's phase center. To determine the coordinates of the station marker, specify the following:

- Measured height of the antenna above the station marker
- Method of measuring the antenna height

- Model of the antenna/receiver used

Any necessary antenna phase center adjustments, based on the antenna model, are automatically applied. These adjustments, when combined with accurately measured height and measurement methods, allow for correctly computed reference marker coordinates.

To accurately measure the antenna height, do the following:

1. Orient the receiver with the display panel facing north.
2. Measure the antenna height above the control point or marker, either the slant height or the vertical height. You may either:
  - Measure the vertical height to the Antenna Reference Point (ARP) located at the bottom of the receiver at the base of the mounting threads.
  - Measure the slant height to the Slant Height Measurement Mark (SHMM) on the side of the receiver.
3. Record the antenna height, points name and start time in the field notes.

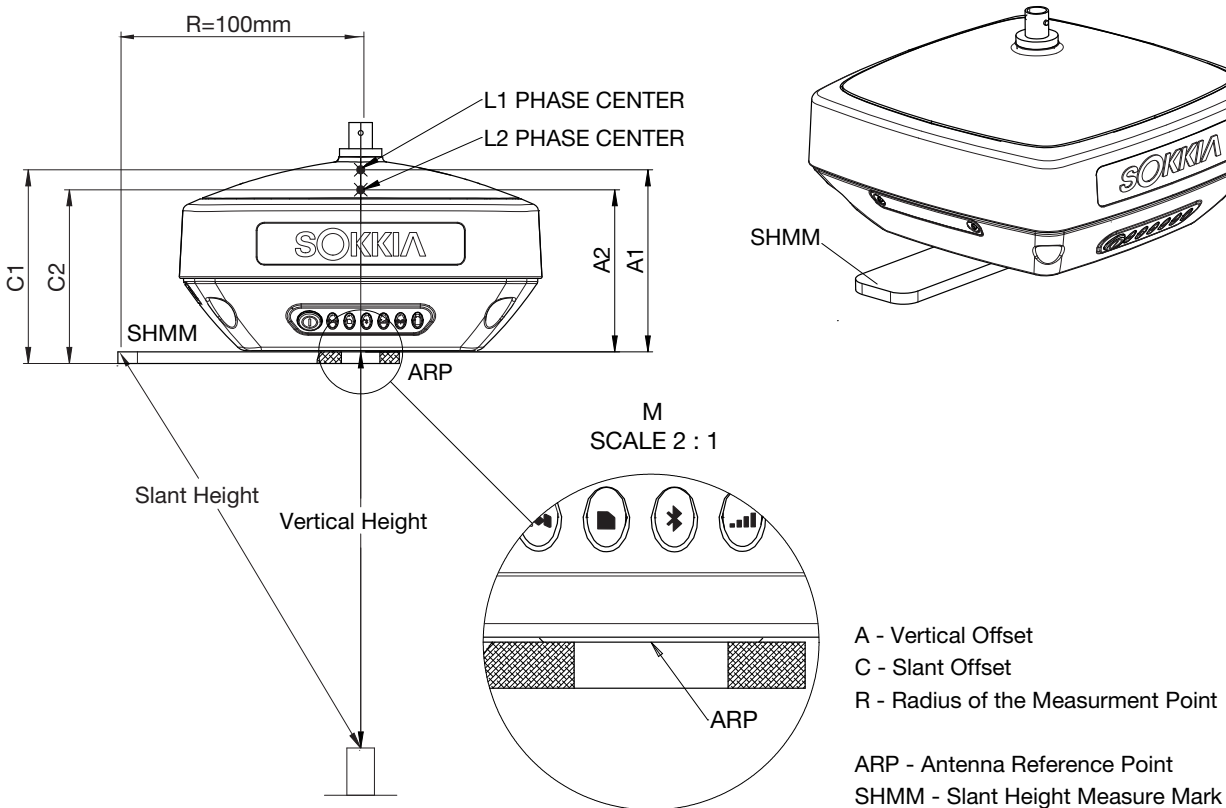

- |                                       |                                 |
|---------------------------------------|---------------------------------|
| 1. C1—Slant offset                    | 7. A1—Vertical offset           |
| 2. C2—Slant offset                    | 8. A2—Vertical offset           |
| 3. SHMM—Slant Height Measurement Mark | 9. Orient to north              |
| 4. R—Radius of measurement point      | 10. ARP—Antenna Reference Point |
| 5. L1—Phase center                    | 11. Vertical height             |
| 6. L2—Phase center                    | 12. Slant height                |

**Figure 6-7: Antenna Height Measurement Points**



# Collecting Data

This chapter provides general information about memory, recording data, downloading data and removing files to free up memory space.

## Memory

The GRX3 is equipped with an internal 8 GB memory card. The memory card is formatted as FAT32. To access the raw, "\*.tps" data files on the memory card, see “Managing Files” on page 7-5.

## Setting Recording Parameters

You can use one of the following ways to set logging parameters, such as logging rate, types of messages and so forth.

- Sokkia Receiver Utility (SRU) software
- MAGNET Field software

## Logging Rates

Memory usage for data logging depends on the logging rate. For more information about setting logging rate parameters, see the *SRU Online Help*.

## Recording Data

You can log GNSS Raw data to the receiver’s memory card and use the Sokkia Receiver Utility (SRU) or MAGNET Office to download the files to a computer.

### Recording Data via the LED Display Panel

To start recording data, using the LED display panel:

1. Press the **Power** button to turn on the receiver.
2. Wait for the Power LED to stop blinking green.

The receiver is now available to log the raw data.



#### NOTE

The receiver is not available to log the raw data until the startup procedure is completed.

3. Press the **Power** button three times in a row within 2 seconds to start recording.
4. Make sure the REC light blinks green, which indicates a "\*.tps" data file has opened and data collection has started.

The REC LED blinks each time data is saved to the internal memory. If the REC light blinks red, the receiver has either a hardware problem or an improper OAF. See “Option Authorization Files” on page 5-7 for more information.

## Stopping Data Recording via the LED Display Panel

To stop recording press the **Power** button three times in a row within 2 seconds and make sure that the REC LED is dark.



**NOTE** With the **Power** button, you can record up to 16 raw, "\*.tps" data files.

## Recording Data Using Sokkia Receiver Utility (SRU)

To start recording data using Sokkia Receiver Utility (SRU):

1. Press the **Power** button to turn on the receiver.
2. Wait for the Power LED to stop blinking green.
3. Do one of the following procedures:
  - If the receiver is connected by a USB connection, use the Safely Remove Hardware and Eject Media feature in Windows and mount the receiver in SRU. For details, see “Ejecting the Receiver from Windows and Mounting in SRU” on page 7-8.
  - If the receiver is connected by a Serial/COM connection, continue to Step 4.
4. Launch SRU and establish the connection with the receiver in the **Receiver Managing** mode. Refer to the SRU Help for more information.
5. Click the **File Explorer**  icon.

The **File Explorer** screen opens (Figure 7-1).

6. Click to open the **Logs** tab.

You can record up to 16 raw, "\*.tps" data files simultaneously, from *A* to *P*. For each file you can use the its own default settings for logging.

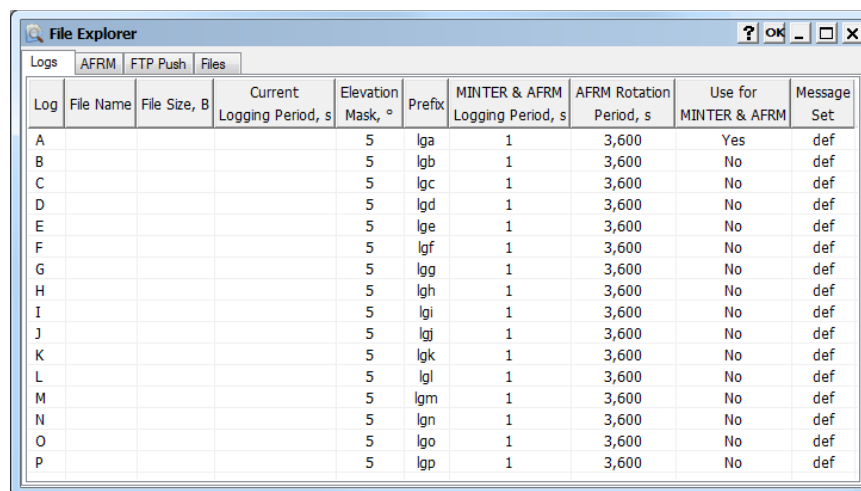

Log	File Name	File Size, B	Current Logging Period, s	Elevation Mask, °	Prefix	MINTER & AFRM Logging Period, s	AFRM Rotation Period, s	Use for MINTER & AFRM	Message Set
A				5	lga	1	3,600	Yes	def
B				5	lgb	1	3,600	No	def
C				5	lgc	1	3,600	No	def
D				5	lgd	1	3,600	No	def
E				5	lge	1	3,600	No	def
F				5	lge	1	3,600	No	def
G				5	lge	1	3,600	No	def
H				5	lgh	1	3,600	No	def
I				5	lgi	1	3,600	No	def
J				5	lgj	1	3,600	No	def
K				5	lgk	1	3,600	No	def
L				5	lgl	1	3,600	No	def
M				5	lgm	1	3,600	No	def
N				5	lgn	1	3,600	No	def
O				5	lgo	1	3,600	No	def
P				5	lgp	1	3,600	No	def

**Figure 7-1: Logs Tab of the File Explorer Screen**

7. Right click on the desired file to open the context menu.

8. Select **Edit** to open the **Log** screen and specify individual settings such as **Elevation Mask**, **Prefix** and **Rotation Period**.

To use these log parameters after pressing the MINTER, select **Use for MINTER & AFRM** (Figure 7-2).

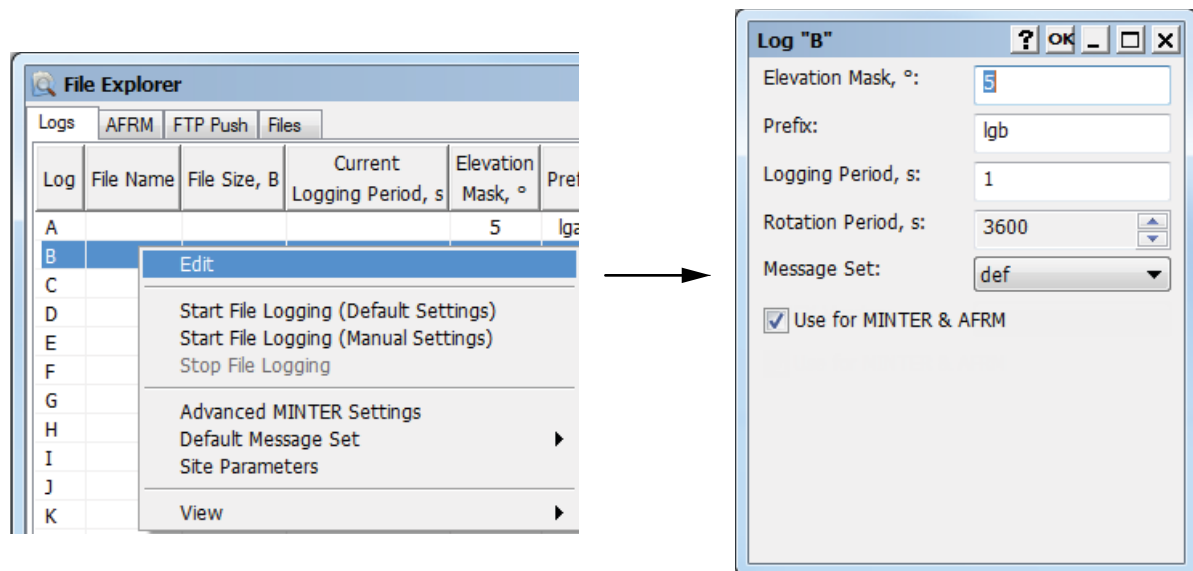

**Figure 7-2: Context Menu of Logs Tab**

9. Click **OK** to save all changes.
10. Using the MINTER, you can start logging one or more files:
  - By default, clicking the **Power** button three times in a row within two seconds will log a file. This file is called File A (Figure 7-4 on page 7-4).
  - By default, the **Use for MINTER & AFRM** check box is enabled only for File A. You can select this check box for any number of files. In this case, clicking the **Power** button will simultaneously start those files for which the **Use for MINTER & AFRM** check box is enabled.

The current logging files are displayed on the **Logs** tab (Figure 7-3).

Log	File Name	File Size, B	Current Logging Period, s	Elevation Mask, °	Prefix	MINTER & AFRM Logging Period, s	AFRM Rotation Period, s	Use for MINTER & AFRM	Message Set
A				5	lga	1	3,600	No	def
B	lgb0808j.tps	17,460	9	15	lgb	9	3,600	Yes	def
C				5	lgc	1	3,600	No	def
D	lgd0808j.tps	13,877	11	10	lgd	11	3,600	Yes	def
E				5	lge	1	3,600	No	def
F				5	lge	1	3,600	No	def
G				5	lge	1	3,600	No	def

**Figure 7-3: Logs Tab with Logging Files**

## Recording Data with Default Settings

To start recording data to the selected file with default settings do the following.

1. Right click on the desired file to open the context menu.
2. Select **Start File Logging (Default Settings)**.

The currently logging file shows in the **Logs** tab (Figure 7-4).

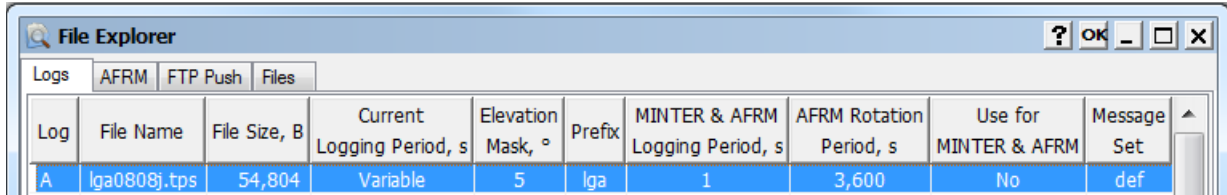

Log	File Name	File Size, B	Current Logging Period, s	Elevation Mask, °	Prefix	MINTER & AFRM Logging Period, s	AFRM Rotation Period, s	Use for MINTER & AFRM	Message Set
A	lga0808j.tps	54,804	Variable	5	lga	1	3,600	No	def

**Figure 7-4: Start File Logging With Default Settings**

## Recording Data with Manual Settings

You can specify the logging parameters manually. To start recording data to the selected file with manual settings, do the following.

1. Right click on the desired file to open the context menu.
2. Select **Start File Logging (Manual Settings)**.

The **Start Logging** dialog window opens.

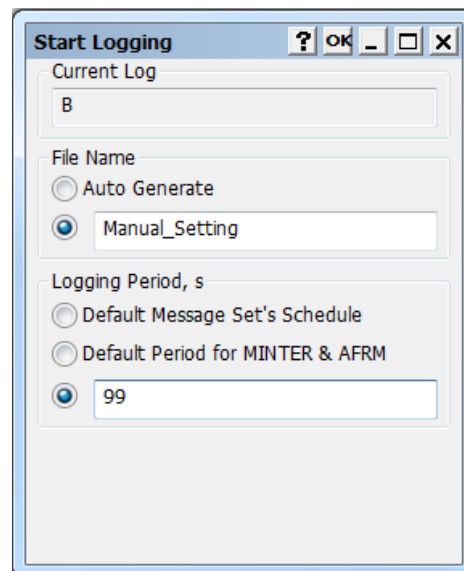

**Start Logging**

Current Log  
B

File Name  
 Auto Generate  
 Manual\_Setting

Logging Period, s  
 Default Message Set's Schedule  
 Default Period for MINTER & AFRM  
 99

**Figure 7-5: Start Logging Dialog Window**

3. Specify the file name and logging period.
4. Click **OK** to start logging the file using the entered parameters.

The current logging file shows in the **Logs** tab (Figure 7-6).

Log	File Name	File Size, B	Current Logging Period, s	Elevation Mask, °	Prefix	MINTER & AFRM Logging Period, s	AFRM Rotation Period, s	Use for MINTER & AFRM	Message Set
A				5	lga	1	3,600	No	def
B	Manual_Setting.tps	10,482	99	15	lgb	9	3,600	Yes	def

**Figure 7-6: File Logging With Manual Settings**

## Stopping Data Recording

To stop recording data, do the following.

1. Right click on the desired file to open the context menu.
2. Select **Stop File Logging**.

The **Files** tab of **File Explorer** screen displays the list of raw, ".tps" data files stored in the receiver memory.



### NOTE

You can also log data using MAGNET Field software. With MAGNET Field, you can record only one raw, ".tps" data file at time.

## Managing Files

The receiver records ".tps" data files to a storage medium with a FAT32 file system. The files and folders are organized in a hierarchical structure. A total of 4000 files can be recorded and stored on the storage medium.

You can program the receiver to:

- Record ".tps" data files up to a maximum of 16 simultaneous files. Each file can be logged with its own parameters.
- Close the current log file and open a new one according to a user-defined schedule. This option is called Automatic File Rotation Mode (AFRM).
- Automatically remove the oldest files to make room for the new files, using storage quotas on the existing files.
- Automatically upload files to an FTP server.

## USB Connection Specifics

After establishing a connection between the GRX3 receiver and a computer or controller using a USB cable:

- The GRX3 receiver is ready to upload and download files between the receiver's memory and the controller or computer's storage.

Windows Explorer shows the receiver's memory storage as a USB drive with the GRX3 folder.

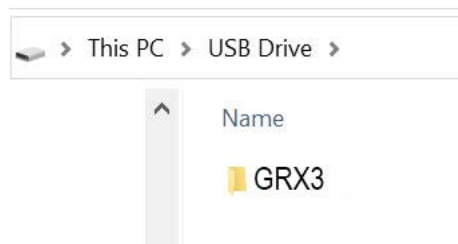

Figure 7-7: GRX3 USB Folder in Windows Explorer



**NOTE**

If the GRX3 storage memory was formatted using SRU, the device name of the receiver will show as **receiver\_serial\_number-I**, where “I” indicates that this is the internal storage memory (Figure 7-8).

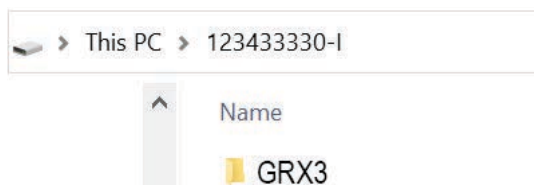

Figure 7-8: GRX3 S/N in Windows Explorer

You can use Windows Explorer to upload and download files to and from the GRX3 receiver.

- The GRX3 receiver **is not** ready to record "\*.tps" data files to memory storage. SRU can **not** access the memory storage or update the firmware.

You can **not** start logging a "\*.tps" data file.

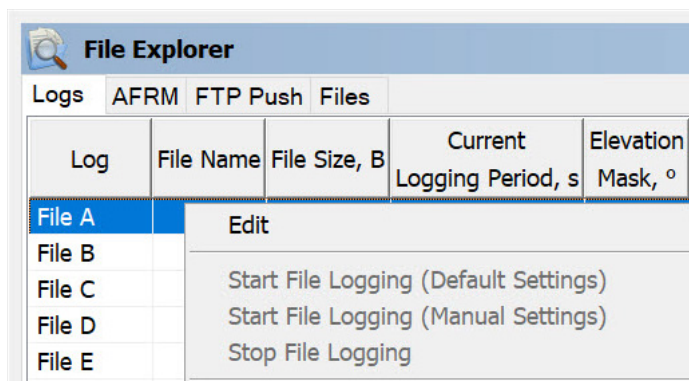
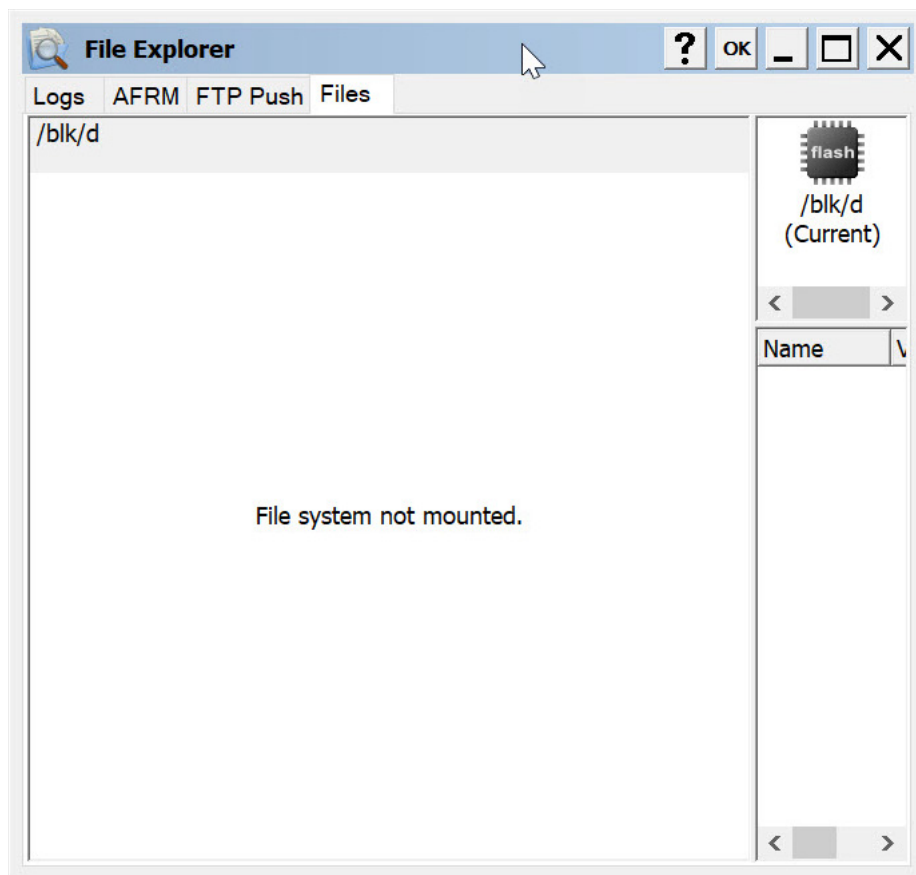

Figure 7-9: SRU File Explorer—Start File Logging Unavailable

You can **not** access the "\*.tps" data files stored in the receiver’s memory.



**Figure 7-10: SRU File Explorer—File System Not Mounted**

You can **not** update the firmware. If you try to update the firmware, the error message in Figure 7-11 shows.

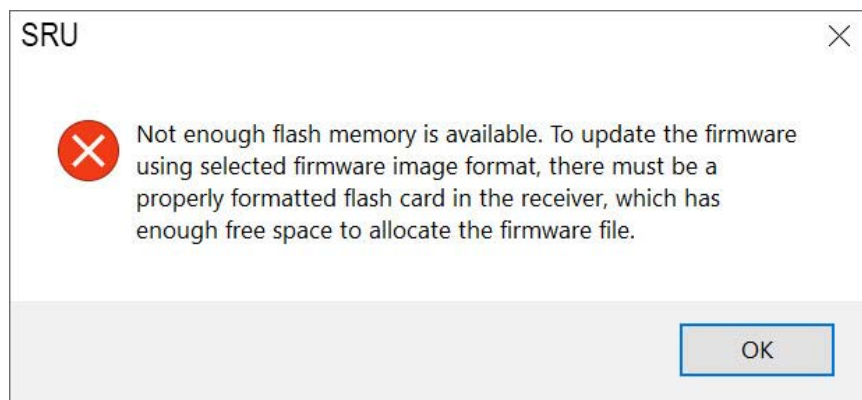

**Figure 7-11: SRU—Not Enough Flash Memory Error**

- The GRX3 receiver is ready for configuration of other receiver settings.

## Ejecting the Receiver from Windows and Mounting in SRU

When the GRX3 receiver is connected by USB, use the **Safely Remove Hardware and Eject Media** feature in Windows to prepare the receiver for any of the following tasks:

- Recording "\*.tps" data files to memory storage
- Accessing the memory storage using SRU
- Updating the firmware using SRU

Do the following on the controller or computer.

1. Use one of the following two procedures:

- From the Windows taskbar:
  - a. Right click the **Safely Remove Hardware and Eject Media** feature in the notification area on the lower right of the screen.
  - b. Select **Eject USB Drive** for the GRX3 from the menu.

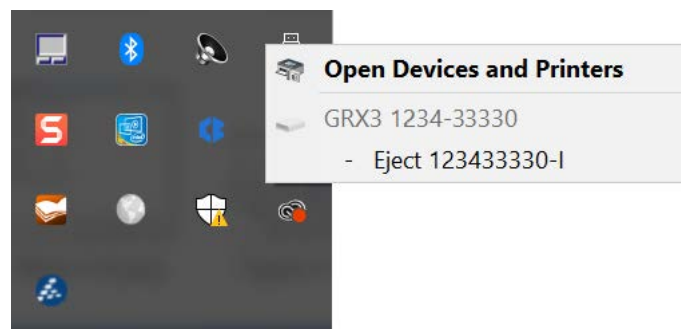

**Figure 7-12: Safely Remove Hardware—Eject USB Drive**

The Safe To Remove Hardware window opens (Figure 7-13). Do **not** disconnect the USB cable from the receiver and the controller or computer.

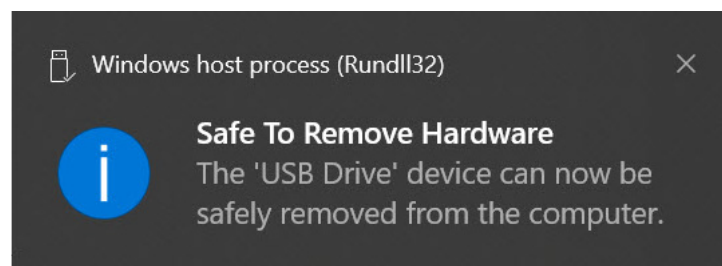

**Figure 7-13: Safe To Remove Hardware**

- From Windows File Explorer:
  - a. Right click the device name of the receiver. This may appear as the receiver's serial number.
  - b. Select **Eject** from the menu.





**Figure 7-14: Eject Device**

The device name of the receiver is removed from Windows File Explorer. The computer or controller is no longer using the USB connection to the receiver.

2. In SRU, click **Device > Application Mode > Receiver Managing**.

Receiver Managing Mode is selected.

3. Click **Device > Connect**.

The **Initializing Connection** window shows briefly.

4. Click **File Explorer**.

The SRU **File Explorer** screen opens.

5. Click **Files**.

The **Files** tab window opens. It shows, *"File system not mounted."*

6. Right click  to select the internal memory.

7. Select **Mount > Mount** from the menu and click **OK**.

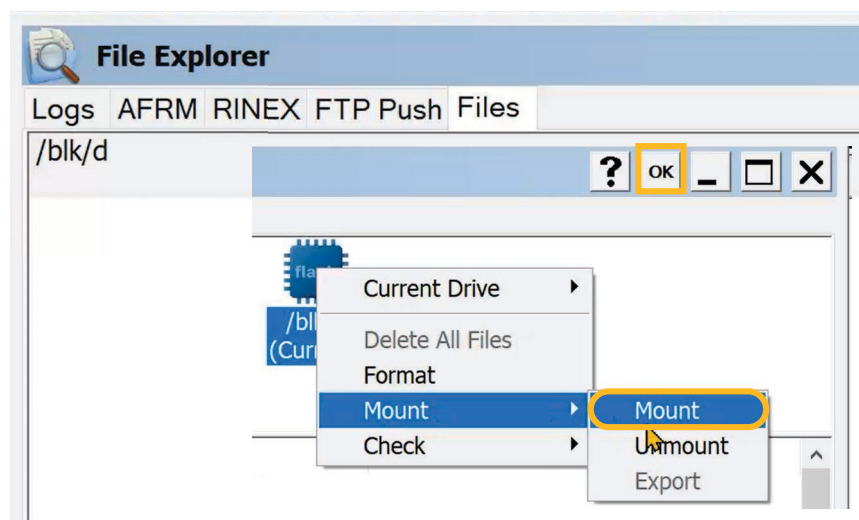

**Figure 7-15: Mount Flash Memory**

The **Files** tab window shows "Initializing," then populates the internal memory information (File System Info, Status, and etc.).

8. Click to open the **Logs** tab.

The GRX3 is ready to record "\*.tps" data files to memory storage. SRU can access files in the memory storage.

## Downloading Data Files Using SRU

When a survey is completed, you can download "\*.tps" data files to a computer for storage, post-processing or backup. To download raw, "\*.tps" data files from the receiver to a computer, do the following.

1. Select the **Files** tab on the **File Explorer** screen.

The **Files** tab displays the list of raw, "\*.tps" data files stored in the receiver memory.

2. Right click on the desired file(s) to open the context menu and select **Download**.

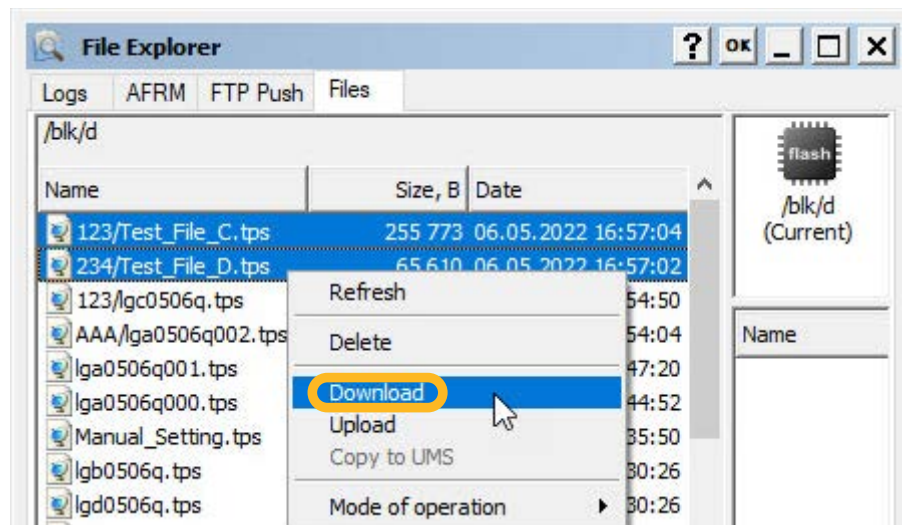

**Figure 7-16: Selecting to Download Files**

3. Select the folder where the "\*.tps" data file(s) will be saved. Click **OK**.

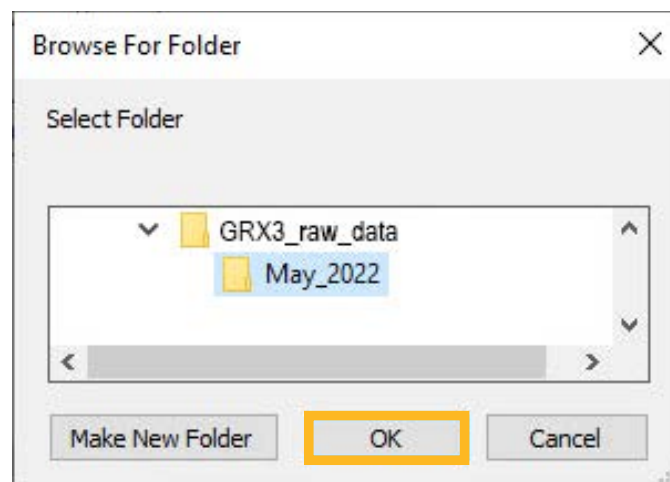

**Figure 7-17: Browse For Folder**

SRU starts downloading the selected file(s) to the folder.

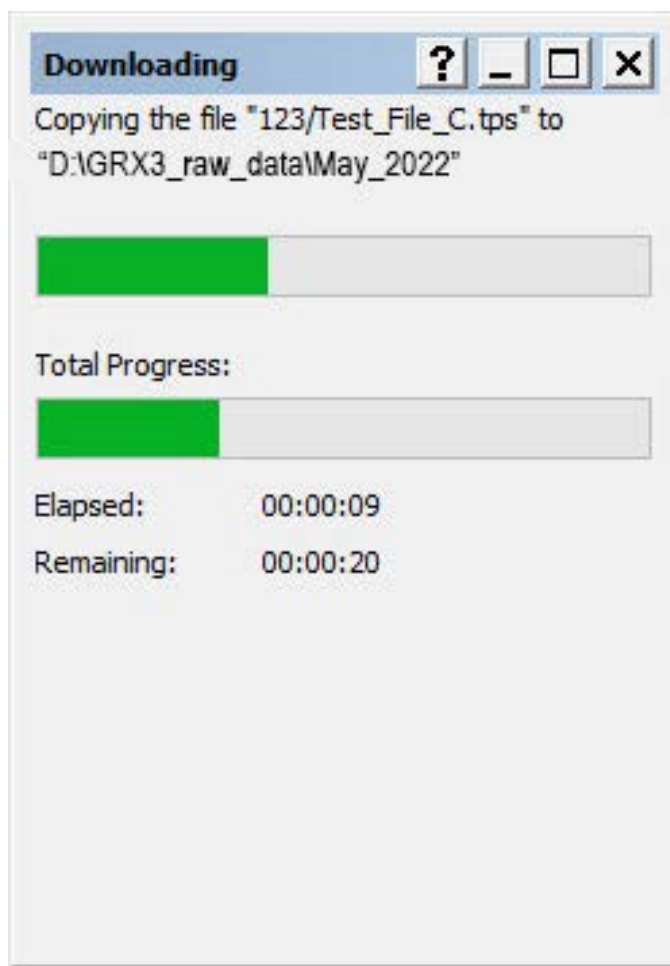

Figure 7-18: Downloading "\*.tps" data file(s) to Computer

## Deleting Data Files from the Receiver Memory Using SRU

When the memory is full, the receiver stops logging data and the REC LED turns dark/off, indicating an error condition. Existing data are not overwritten.

To delete raw, "\*.tps" data files from the internal memory of receiver do the following:

1. Right click on the desired file(s) to open the context menu and select **Delete**.
2. Click **Yes** to confirm, then click **OK**.

SRU starts deleting the selected file(s) from the receiver memory.

# Troubleshooting

This chapter will help you diagnose and solve some common problems that may occur with the receiver.



## CAUTION

Do not attempt to repair equipment yourself. Doing so will void the warranty and may damage the hardware.

## Check This First

Before contacting your local dealer or Sokkia Technical Support, check the following:

- Check all external receiver connections carefully to ensure correct and secure connections. Double check for worn or defective cables.
- Check the receiver's internal battery for a full charge.
- Check the power source for incorrectly connected cables and ensure the power source is valid. See "Cellular Module RF Connector" on page 9-9 for external power requirements.
- Check the software. Make sure the most current software version is downloaded onto the computer and the most current firmware is loaded into the receiver. Check the Sokkia Care website for the latest updates.
- Check Sokkia Care (<https://us.sokkia.com/sokkia-care>) for the latest updates.

Then, try the following:

- Power on and off the receiver by pressing the Power button or by using SRU (**Tools > Reset receiver**).
- Restore default settings by clearing the NVRAM. See "Perform a Factory Reset Using the LED Display" on page 5-13. This restores the receiver's parameters to the factory default settings and erases the almanac and ephemeris files. This action does not delete data files from the receiver memory.

If the problem persists, see the following sections for other solutions.

## Powering Problems

The following are some of the most commonly encountered power problems.

### The Receiver Does Not Power Up

The battery may be discharged.

- Charge the battery overnight. See "Charging the Battery" on page 4-3.
- If you are using an external power source, the cable may be disconnected or damaged.
  - Make sure that the cable is securely connected and undamaged.
- The receiver may have a defective charger or defective battery.

- If, after changing the battery or connecting an external power source, the receiver still does not power up, contact your local dealer or Sokkia Technical Support for advice.

If the internal battery is charged, reset the hardware using the Hardware Reset button. See “Receiver Enclosure—Bottom Overview Labels” on page 2-5.

## Receiver Problems

The following are some of the most commonly encountered receiver problems.

### The Receiver Cannot Establish a Connection to a Computer or External Controller

Cable specific problems:

- The cable is not properly plugged in.
  - Unplug the cable, then securely and properly reconnect it to the receiver.
- The cable is damaged.
  - Use an undamaged cable. Contact a dealer to replace the cable.
- The cable is connected to a computer running Windows 7 and the USB driver is not installed.
  - If you are using a USB cable connection with a computer running Windows 7, make sure the USB driver is installed on the computer. You can download the driver from Sokkia Care at: <https://us.sokkia.com/sokkia-care-products/grx3-gnss-receiver>.

### Generic problems:

- The receiver port used for connection is not in Command mode.
  - a. Connect the receiver to a computer and open SRU (see “Connection” in the *Sokkia Receiver Utility (SRU) Help* embedded in the software).
  - b. Click **Receiver Settings > Ports**.
  - c. Change the **Input Mode** for the port used for connection to **cmd**.

### The receiver does not lock on to satellites for a long period of time

- The corresponding receiver options may be disabled or expired (L1/L2, GPS/GLONASS must be on to track satellites).
  - Order a new OAF with the desired options activated to enable or extend validity of the corresponding receiver options. Contact a dealer or visit the Sokkia website for details.
  - Refer to the “Receiver Managing” chapter of the *Sokkia Receiver Utility (SRU) Help* for a detailed description of options.

### The receiver tracks too few satellites

- If the survey is conducted near obstructions (tree canopy, tall buildings and so forth).
  - Make sure that the Multipath Reduction boxes have been enabled in the field data collection software.

- a. Connect the receiver to a computer and open SRU (see “Connection” in the *Sokkia Receiver Utility (SRU) Help* embedded in the software).
  - b. In SRU, connect to the receiver.
  - c. On the SRU main screen, choose **Receiver Settings > Tracking > Adv** tab. Make sure the **C/A code multipath reduction** check box is selected.
- Move to an area free of obstructions, if possible.

### The receiver cannot obtain Code Differential and/or RTK solutions

- Incorrect Base coordinates entered.
  - Specify the correct coordinates for the Base station using SRU or another suitable field data collection software.
  - There could be some obstruction to the connection.
  - Clear all possible obstructions or relocate the Base so there is a “line-of-sight” path to the Rover.
- The corresponding receiver options may be disabled or expired.
  - Order a new OAF with the required options activated to enable or extend validity of the corresponding receiver options.
  - Refer to the *Sokkia Receiver Utility (SRU) Help* for a detailed description of options.
- There are not enough common satellites. In order to obtain a fixed solution, the Base and Rover should track at least five common satellites.
  - Check the elevation masks of the Rover and Base receivers; they should be the same. To do this, on the SRU main window, choose **Receiver Setting > Tracking > Obs**.
  - Verify there is a clear view of the sky to allow sufficient satellite tracking.
- A discrepancy exists between the differential standards used at the Base and Rover receivers.
  - Ensure the Base and Rover receivers use the same corrections input/output format:
    - a) Connect the receiver to a computer and open SRU (see “Connection” in the *Sokkia Receiver Utility (SRU) Help* embedded in the software).
    - b) In SRU, connect to the receiver.
    - c) On the SRU main window, choose **Receiver Settings > Ports**.
    - d) Double-click on the port to be configured and make sure the input mode of the Rover matches the format of the Base output mode (i.e. RTCM3).
- Poor satellite geometry (PDOP/GDOP values are too high).
  - Conduct the survey where satellite visibility is better (low PDOP value).
  - Ensure the elevation mask is less than 10 degrees.

- Increase the PDOP threshold. To do this, on the SRU main window, choose **Receiver Settings > Tracking > Obs.**
- The elevation mask is above 10 degrees.
  - Lower the elevation mask. To do this, on the SRU main window, choose **Receiver Settings > Tracking > Obs.**
  - Verify there is a clear view of the sky to allow sufficient satellite tracking.
- The modem battery is low.
- The specified baud rate is incompatible with the baud rates the modem supports. The baud rate is the rate at which the receiver transmits differential messages to the modem and vice versa.
  - Change the modem's baud rate.
- The Base and Rover modems use different radio link parameters.
  - Configure the Base and Rover radio modems according to the procedures listed in the *SRU Help*.
- The distance between the Base and Rover is too far.
  - Close the distance between the Base and Rover.
  - Use repeaters to increase radio coverage.
- There may be a source of radio interference that disrupts radio communications.
  - Change the RF channel (if possible).
  - Removing the source of the jamming signal or relocate the radio antennas (if possible).

**The receiver does not start logging data**

- The receiver's memory is disabled or expired.
  - Make sure the memory option is enabled. For details, see the *Sokkia Receiver Utility (SRU) Help*.
- The internal memory does not have free space.
  - Download and/or delete data files to free up space for new files. See "Downloading Data Files Using SRU" on page 7-10.
  - The file system is not initialized. Initialize the File System on the internal memory using SRU. To do this, on the SRU main screen, choose **File Explorer > Initialize File System**.

# Bluetooth Problems

The following are some of the most commonly encountered error messages and other problems.

## SRU error message: Cannot find receiver

- The receiver is turned off.
  - Ensure the receiver has power and is turned on.
- Bluetooth is not turned on; the BT LED is off.
  - Reset the receiver to the factory default settings by pressing the Power button for 10 to 15 seconds.
  - You can also turn on power to Bluetooth using SRU. To do this, on the SRU main window, choose **Receiver Settings > Bluetooth**.
- There is interference.
  - Move the receiver, controller or computer to an unobstructed location.
- The receiver is too far away.
  - Move the devices closer together.
- The receiver is already connected via Bluetooth to another device.
  - Disconnect the receiver from the other controller or computer.
- The receiver port used for connection is not in Command mode.
  - a. Connect the receiver to a computer and open SRU (see “Connection” in the *Sokkia Receiver Utility (SRU) Help* embedded in the software).
  - b. Click **Configuration > Receiver > Ports**.
  - c. Change the **Input Mode** for the Bluetooth serial port used for connection to **cmd**.



### NOTE

This is the most common cause for this error message. Use SRU to double check the settings for the connection port.

## SRU error message: Open COM# port failed: Access is denied.

- Another application uses the computer port dedicated for connection.
  - Close the application and then re-connect.
  - Connect the receiver via another, unused computer port.

## After searching for available devices, none are discovered

- The receiver is not receiving power.
  - Check that the receiver is getting power and is turned on.



- Check that the power cable is correctly attached to the port if one is being used.
- Unplug the cable, then securely and properly reconnect it to the receiver.
- If the power cable is damaged, contact a Dealer to purchase a new cable.

**You Can see the icon for the receiver’s Bluetooth module on the computer screen, but cannot connect to it**

- Device security settings probably differ.
  - Make sure the Bluetooth enabled devices use the same security settings.
- Bluetooth module settings may have changed.
  - a. If the settings are changed for the Bluetooth module, remove it from the list of discovered Bluetooth devices using the Bluetooth manager program (supplied with the device used to manage the receiver).
  - b. Repeat the search.

## SRU Problems

The following is the most commonly encountered SRU problem.

**SRU cannot connect to the receiver**

- The receiver is turned off.
  - Ensure the receiver has power and is turned on.
- If using a cable, the cable’s connectors are improperly attached.
  - Check that the cable connector is attached to the correct serial port.
  - Unplug the cable, then securely and properly reconnect it to the receiver.
- If using a cable, the cable is damaged.
  - Use an undamaged cable.
  - Contact a dealer to purchase a new cable.
- If using Bluetooth wireless technology, the incorrect port is selected.
  - Use a computer or receiver that has Bluetooth wireless technology enabled/installed.
  - Make sure the computer and receiver use the correct ports for communication—For the GRX3 receiver, this is Bluetooth serial port A (btsp\A).

**SRU error message: Not enough flash memory is available. To update the firmware using selected firmware image format, there must be a properly formatted flash card in the receiver, which has enough free space to allocate the firmware file.**

- Use the **Safely Remove Hardware and Eject Media** feature in Windows and mount the receiver in SRU. For details, see “Ejecting the Receiver from Windows and Mounting in SRU” on page 7-8.

## Cleaning and Storing the Receiver

- Use a clean cloth moistened with neutral detergent or water.
- Never use an abrasive cleaner, ether, thinner benzene or other solvents.
- Always make sure the receiver is completely dry before storing it. Dry any moisture with a soft, clean cloth.

## Getting Customer Support

If the troubleshooting hints and tips in this operator's manual fail to remedy the problem, contact your local Sokkia dealer or visit Sokkia Care (<https://us.sokkia.com/sokkia-care>) for technical support. For contact information, see "Getting Technical Support" on page 1-4.

# Specifications

This chapter describes the internal component specifications for the GRX3.

## General Details

Table 9-1 lists the receiver's general specifications.

**Table 9-1. General Receiver Specifications**

Item	Specification
<b>Physical</b>	
Enclosure	Magnesium Alloy housing
Color	Sokkia Gray/Blue bumper
Dimensions (mm)	149 (w) x 149 (l) x 94.6 (h)
Weight (kg)	1.061
Internal GNSS Antenna	Internal integrated Full wave Fence Antenna Technology with internal ground plane
External GNSS Antenna	(available only in non-cellular receivers) Connector: SMB Nominal impedance: 50 Ohm LNA power: +4.5 to 5.5 @ 0-120 mA Over current protection values: minimum: 102 mA, typical: 115 mA, maximum: 140 mA
External Cellular Antenna	Connector: SMA Signal type: GSM/LTE (available only in integrated cellular receivers)
Battery	Internal battery contains two Lithium-ion internal battery packs. Each pack is 3.6 V, 6.96 Ah, 25.1 Watts
Seals	Silicon (molding in color)
Key	1 Power Key – On/Off and Start/Stop Data Logging
LEDs	7 status LEDs: <ul style="list-style-type: none"> <li>● Power</li> <li>● STAT</li> <li>● REC</li> <li>● Bluetooth</li> <li>● Cellular</li> <li>● Radio</li> <li>● BATT</li> </ul>

Table 9-1. General Receiver Specifications (Continued)

Item	Specification
Port, Bus and Connectors	1 Port: <ul style="list-style-type: none"> <li>● Serial</li> </ul> 1 Bus <ul style="list-style-type: none"> <li>● USB Serial</li> </ul> 3 Connectors <ul style="list-style-type: none"> <li>● Power</li> <li>● External GNSS antenna or external cellular antenna</li> <li>● External Radio antenna</li> </ul>
<b>Environment</b>	
Operating Temperature	<ul style="list-style-type: none"> <li>● -20°C to +50°C (Battery power/Non-charging)</li> <li>● 0°C to +40°C (External power supply/Battery charging)</li> <li>● -40°C to +65°C per MIL-STD 810G</li> </ul>
Storage Temperature	-40°C to +85°C
Humidity	100%
Ingress Protection	Dust and water ingress protected (IP67)
Vibration	Random: MIL-STD 202G, Method 214A Mechanical: Compliance with MIL-STD 810G - 516.6
Drop	Survive 2 meter pole drop onto concrete surface Survive 1 meter handle drop
<b>Power</b>	
Battery	Internal: two Lithium-ion battery packs, 3.6 V Total capacity: 13.2 Ah, 50.2 Watts
Operating Time  Average with modem “on” and 20 SVs tracked.  Using new, fully-charged battery, operating at room temperature and transmitting at 1-Hz rate.	For the GRX3 with R2 Lite UHF Modem: <ul style="list-style-type: none"> <li>● Receive-only mode – 10 hours</li> <li>● Transmitting at 0.5 W – 8 hours</li> <li>● Transmitting at 1 W – 6 hours</li> </ul> For the GRX3 without a Modem: <ul style="list-style-type: none"> <li>● Modem off – 15 hours</li> </ul> For the GRX3 with R2 Lite UHF and 4G/LTE <ul style="list-style-type: none"> <li>● UHF, Receive-only UHF mode – 10 hours</li> <li>● UHF, Transmitting at 0.5 Watts – 8 hours</li> <li>● UHF, Transmitting at 1 Watt – 6 hours</li> <li>● LTE/Cellular, Receive-only mode – 12 hours</li> </ul>
External Power Connector	ODU-5
Input Voltage	9 – 27 VDC
Battery Charge	Connect external power to charge internal battery.

Table 9-1. General Receiver Specifications (Continued)

Item	Specification
Charging Time	Approximate – 5 hours for full charge using manufacturer-supplied battery charging cradle (P/N 1010975-02) and adapter (P/N 1005556-01).
On-board	Backup battery for timekeeping and almanac data storage; minimum 10 years of operation
<b>GNSS Receiver Board Details</b>	
Number of Channels	226 GNSS channels Vanguard Technology™ with Universal Tracking Channels <sup>a</sup>
Tracked Signals	GPS: L1 C/A, L1C, L1P(Y), L2P(Y), L2C, L5 GLONASS: L1 C/A, L1P, L2P, L2C/A, L3 Galileo: E1, E5a, E5b, E5AltBOC BeiDou: Phase 2: B1I, B2I; Phase 3: B1I, B1C, B2a, B2b NavIC: SPS-L5A SBAS: L1 C/A, L5 QZSS: L1 C/A, L1 C/B, L1C, L2C, L5 L-band: 1525-1560 MHz
<b>Tracking</b>	
Multi-path Reduction	Yes, code and carrier
PLL/DLL Settings	Bandwidth, order, adjustable
SBAS	WAAS/EGNOS/MSAS/GAGAN
Quartz Lock Loop (QLL)	Protection against vibrations
<b>Data</b>	
USB	USB Micro-A/B Device Mode - Mass storage, virtual serial
Input Format <sup>b</sup>	<ul style="list-style-type: none"> <li>● TPS proprietary</li> <li>● RTCM SC104 version 2.X, RTCM 3.X</li> <li>● Encrypted RTK</li> <li>● CMR/CMR+</li> </ul>
Output Format <sup>b</sup>	<ul style="list-style-type: none"> <li>● TPS proprietary</li> <li>● RTCM SC104 version 2.X, RTCM 3.X (including MSM)</li> <li>● CMR/CMR+</li> <li>● BINEX</li> <li>● NMEA 0183 versions 2.1, 2.2, 2.3, 3.0, 3.01, 4.0, 4.10, 4.11</li> </ul>
Features	Up to 20 Hz update rate for real time position and raw data
ASCII Output	ASCII output NMEA 0183 versions 2.1, 2.2, 2.3, 3.0, 3.01, 4.0, 4.10, 4.11

Table 9-1. General Receiver Specifications (Continued)

Item	Specification
Data Logging	Support for sixteen simultaneous sessions Advanced file/folder system
<b>Memory</b>	
Type of Memory	SD (Secure Digital) non-removable card
Capacity	8 GB pre-installed
Number of Files	Up to 4000
Logging Size	6.0 MB per hour (32 SVs, 1-second, L1/L2, default message set)
Logging Interval	0.01 – 86,400 seconds, depending on purchased options
<b>Output</b>	
Communication Ports	<ul style="list-style-type: none"> <li>High-speed RS-232 serial port (rimmed in green)</li> <li>USB 2.0 up to 480 Mbps -USB device with mass storage and virtual serial port functionality</li> <li>Internal Cellular Module (optional)</li> </ul>
Bluetooth	Class 1; Up to 50 meters (indoor)
SiteComm Bluetooth Technology	Up to 328 meter range with up to 3 simultaneous rover connections. Typical long-range distance with clear line of sight. Distance for long-range largely depends upon environmental and field conditions.
Serial Port Specifications	RS-232 Serial Port: <ul style="list-style-type: none"> <li>Baud rate: 460800, 230400, 115200 (default), 57600, 38400, 19200, 9600, 4800, 2400, 1200, 600, 300</li> <li>Flow control: RTS/CTS</li> <li>Length: 7 or 8 (default)</li> <li>Stop bit: 1 (default), 2</li> <li>Parity: None (default), Odd, Even</li> </ul>
Connectors	<ul style="list-style-type: none"> <li>UHF Modem Antenna (BNC)</li> <li>PWR</li> <li>RS-232 Serial</li> <li>USB 2.0 Micro-A/B</li> <li>External GNSS antenna or external cellular antenna</li> </ul>
MINTER (LED Display)	<ul style="list-style-type: none"> <li>6 external LEDs</li> <li>ON/OFF control input (power button)</li> </ul>
<b>NMEA</b>	
NMEA 0183 Output	Version 2.x, 3.x and 4.x
Messages	GGA, GLL, GMP, GNS, GRS, GSA, GST, GSV, HDT, RMS, ROT, VTG, UID and ZDA

Table 9-1. General Receiver Specifications (Continued)

Item	Specification
Output Interval	1-Hz standard; 5, 10, 20 Hz optional
<b>DGPS</b>	
Correction Format	RTCM SC104 Version 2.x and 3.x
RTCM Message Type	1, 3, 9, 31, 32, 34—user selectable
Process Interval	1-Hz standard; 10, 20 Hz optional
Output Interval for RTCM Correction Data	1-Hz standard; 10, 20 Hz optional
Elevation Mask	0 to 90 degrees (independent of data logging)
<b>Real-Time Kinematic Mode</b>	
Correction Format <sup>b</sup>	RTCM SC104 Version 2.x, RTCM 3.x, RTCM 3.X MSM3, CMR/CMR+ (Trimble compatible), TPS proprietary
Supported RTK Network Solutions	VRS, MAC, FKP
Ambiguity Initialization	On-The-Fly (OTF): L1, L1/L2, L1/L2/L5
Baseline Length	Up to 50 KM, depending on atmospheric and multi-path conditions
Initialize Time	From 1-second depending on the baseline length (D) and multi-path conditions
Output Interval for CMR/RTCM	1-Hz standard; 10, 20 Hz optional
Elevation	0 to 90 degrees (independent of data logging)
Solution Mode	Delay (synchronization) mode Extrapolation (not synchronized) mode
Process Interval	1-Hz standard; 10, 20 Hz optional
<b>Survey Modes</b>	
Base or Rover	Autonomous (standalone) DGPS (w/user base) DGPS (w/SBAS) Static Kinematic (continuous, stop and go) RTK (delay, extrapolation)
<b>Positional Accuracy<sup>c</sup></b>	
Standalone	Horizontal 1.2 meters Vertical 1.8 meters
RTCM based DGPS	Horizontal <0.25 meters Vertical <0.50 meters

**Table 9-1. General Receiver Specifications (Continued)**

Item	Specification
SBAS	Horizontal <1.0 meter Vertical <1.5 meter
Topnet Live Starpoint (Pro) PPP correction service <sup>d</sup>	Horizontal <0.1 meters (95%) Vertical <0.2 meters (95%)
Precision Static	Horizontal 3 mm + 0.1 ppm Vertical 3.5 mm + 0.4 ppm
Static/Fast Static	Horizontal 3 mm + 0.4 ppm (x baseline length) Vertical 5 mm + 0.5 ppm (x baseline length)
RTK Static	Horizontal 3 mm + 0.8 ppm (x baseline length) Vertical 5 mm + 1.0 ppm (x baseline length)
RTK Kinematic /Stop&Go/Network	Horizontal 5 mm + 0.5 ppm (x baseline length) Vertical 10 mm + 0.8 ppm (x baseline length)
Kinematic, RTK, Network RTK	L1+L2: H: 5 mm + 0.5 ppm (x baseline length) V: 10 mm + 0.8 ppm (x baseline length)
RTK, TILT Compensated	Horizontal 1.3 mm/°Tilt; Tilt ≤ 10° Horizontal 1.8 mm/°Tilt; Tilt > 10° Maximum recommended angle for tilt compensation is 15°
Cold Start Warm Start Reacquisition	<40 seconds <20 seconds <1 second
RTK Time-to-First-Fix (TTFF)	<20 seconds

a. Vanguard ASIC includes four additional dedicated channels for L-Band signal tracking.

b. CMR/CMR+ is a third-party proprietary format. Use of this format is not recommended and performance cannot be guaranteed. Use of industry standard RTCM 3.x is always recommended for optimal performance.

c. Subject to multi-path anomalies, interference, atmospheric conditions and atypical satellite geometry. GNSS survey best practices must always be applied.

d. Once converged



# R2 Lite UHF Internal Modem Board Details (Optional)

Table 9-2 lists GRX3's optional R2 Lite UHF modem specifications.

**Table 9-2. R2 Lite UHF Internal Modem Board Specifications**

Item	Specification
Operating Frequency Range	406 – 470 MHz for Rover and Base
Channel Spacing	6.25 KHz <sup>a</sup> /12.5 KHz/25 KHz user-selectable
Signal Modulation	<ul style="list-style-type: none"> <li>• 4FSK</li> <li>• GMSK</li> </ul>
Communication Mode	Time division duplex
Supported Protocol(s)	TPS, PDL, Trimble, Satel 3AS
Transmitter Carrier Power	100, 200, 500 and 1000 mW, user selectable
Receiver Sensitivity	GMSK: -115 dBm @ 10 <sup>-5</sup> BER and 12.5 KHz spacing 4FSK: -106 dBm @ 10 <sup>-5</sup> BER and 12.5 KHz spacing
Receiver Dynamic Range	-110 to -10 dBm
Serial Data Rate	115200 bps
Radio Data Rate	25 KHz: 9600 bps for GFSK and 19200 bps for 4FSK 12.5 KHz: 4800 bps for GMSK and 9600 bps for 4FSK
Antenna Type	Whip antenna
Antenna Connector	BNC
Error Correction	FEC on/off

a. 6.25 KHz Channel Spacing approved for Australia only.

## General Recommendation for Highly Reliable Radio Links

1. Maintain the use of Forward Error Correction (FEC) when in challenging radio environments such as urban areas. FEC is the default option in the R2 Lite radio modem firmware.
2. Use Received Signal Strength Indication (RSSI) to measure the radio environment before using GNSS receivers on a job site. RSSI values are available to our end users through our GNSS field application software and is an integral part of all GNSS systems. For more sensitive job sites like airport construction, our customers and professional service team members are trained to use a spectrum analyzer and other typical radio tools to ensure that the environment is free from radio signal jamming or interference.
3. Co-operation with the local radio governing authorities to find out the optimum free radio channel.
4. Avoid using channels nearby local TETRA or television frequencies, which are generally not recommended for use in this application.

5. Use a repeater in an intermediate position, to extend the length of the link and/or increase the receive signal level at the rover.

### Adjacent Channel Selectivity

If rare occurrence of base and rover receivers' interference is reported, the user has the following options:

1. Use an alternate licensed channel that is more than one channel away from the adjacent transmitter; or
2. Decrease the distance to the transmitting base station by relocating the base closer to the rover position, thus increasing the signal level received at the rover by more than 6 dB.

### Receiver Spurious Response Rejection

If the radio receiver is disturbed by a spurious frequency, one of the following proposal candidates can be used:

1. Use an alternate licensed channel that is located farther away from the spurious frequency.
2. Decrease the distance to the transmitting base station by relocating the base closer to the rover position, thus increasing the signal level received at the rover by more than 4 dB.

## Bluetooth Module Details

Table 9-3 describes GRX3's Bluetooth module specifications.

**Table 9-3. Bluetooth Module Specifications**

Item	Specification
Range	Up to 50 meters/164.05 ft. (indoor); Up to 328.1 meters/1000 ft. (outdoor)
Type	Class 1
Service Classes	Miscellaneous
Supported Profiles	SPP, SiteComm
Frequency Country Code	North America and Europe

## Connector Specifications

GRX3 has one antenna connector for radio transmission/reception and four data and port connectors for power, serial communication, micro-USB and the external GNSS antenna or external cellular antenna. The SiteComm and Bluetooth antennas are internal.



### NOTICE

Cellular models of the GRX3 have an external cellular module antenna connector (Figure 2-3 on page 2-2).

## Radio (Modem) RF Connector

The modem connector (Table 9-4) is a BNC connector for UHF radio.

**Table 9-4. Modem Connector Specifications**

Modem	Type	Signal Type	Dir	Details
UHF	BNC	Modem I/O	I/O	RF output from modem antenna

## Cellular Module RF Connector

The cellular module connector specifications are listed below in Table 9-5.

**Table 9-5. Modem Connector Specifications**

Module	Type	Signal Type	Dir	Details
Cellular	SMA Connector	GSM/LTE I/O	I/O	RF input and output from cellular antenna

## Power Connector

The power connector (Figure 9-1) is a sealed receptacle, 5 pin, ODU (P/N G80F1C-T05QF00-0000).

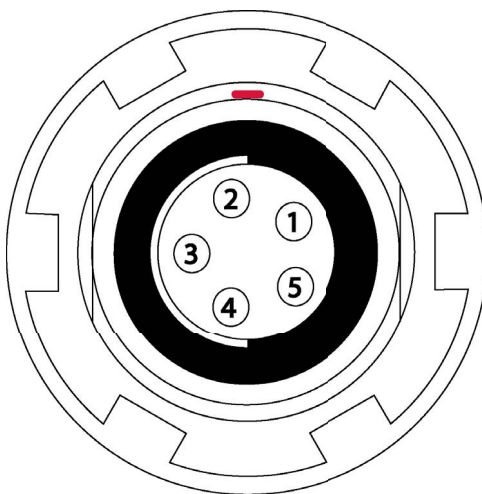

**Figure 9-1: Power Connector**

Table 9-6 describes power connector specifications.

**Table 9-6. Power Connector Specifications**

Number	Signal Name	Dir	Details
1	Power_INP	P	9 – 27 volts DC input
2	Power_INP	P	9 – 27 volts DC input
3	Power_GND	P	Ground, power return
4	Power_GND	P	Ground, power return
5	Aux_Power	P	9 – 27 volts DC input

## Serial RS-232 Connector

The Serial RS-232 connector (Figure 9-2) is a sealed receptacle, 7 pin, ODU (P/N G80F1C-T07QC00-0000).

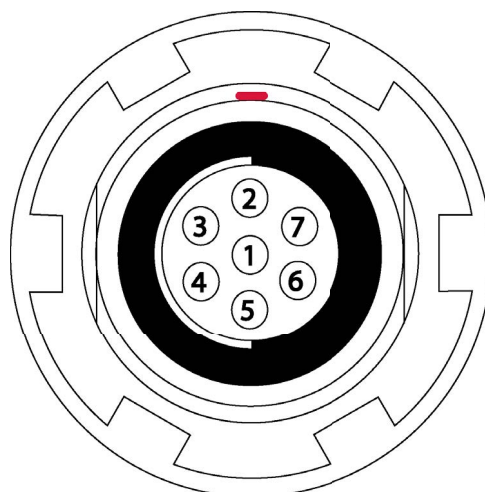

**Figure 9-2: Serial C RS-232 Connector**

Table 9-7 describes the RS232 cable connector specifications.

**Table 9-7. RS-232 Connector Specifications**

Number	Signal Name	Dir	Details
1			Not used
2	GND	-	Signal ground
3	CTS	I	Clear to send
4	RTS	O	Request to send
5	RXD	I	Receive data
6	TXD	O	Transmit data
7	PPS	O	1-PPS

## Micro-USB Connector

The micro-USB connector is a standard 5-pin, micro-USB, A/B connector (Figure 9-3).

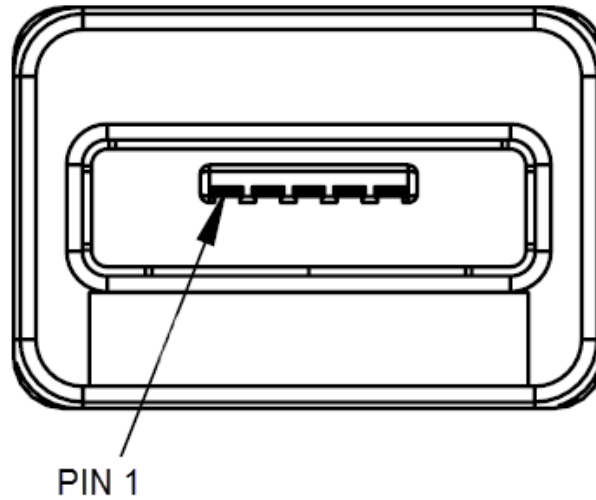

**Figure 9-3: USB Connector for GGD Options**

Table 9-8 describes the micro-USB connector specifications.

**Table 9-8. Micro-USB Specifications**

Number	Signal Name	Dir	Details
1	USB_PWR	P	Bus power input
2	USB D-	I/O	Data minus
3	USB D+	I/O	Data plus
4	ID	I	USB ID
5	GND	P	Ground

# Product Identification

The GRX3 receiver is available in the configurations and assembly part numbers shown in Table 10-1. The corresponding part numbers for the radio and cellular antennas to be paired with the receiver configuration are as indicated.



**NOTE**

Receiver assembly variants may differ based upon your country or region. Contact your local Sokkia dealer to inquire about availability in your area.

**Table 10-1. Assembly and Product Part Numbers**

Assembly Part Number	Radio Antenna P/N	Cellular Antenna P/N
<b>No radio, no cellular module</b>		
1028556-02 1028556-10 1028556-12	N/A	N/A
<b>R2 Lite UHF radio</b>		
1028556-01 1028556-09 1028556-11 1028556-20	30-050501-01	N/A
<b>R2 Lite UHF radio, with integrated 4G/LTE cellular module</b>		
1028556-05 1028556-15	30-050501-01	1030630-01
<b>Alinco UHF radio (available in Japan)</b>		
1028556-03	1014712-01	N/A
<b>Alinco UHF radio (available in Japan), with integrated 4G/LTE cellular module</b>		
1028556-04	1014712-01	1030630-01

# Safety Warnings

## General Warnings



### CAUTION

To comply with RF exposure requirements, maintain at least 37 cm between the user and the radio modem.



### CAUTION

TPS receivers are designed for survey and survey related uses (that is, surveying coordinates, distances, angles and depths and recording such measurements). This product should never be used:

- Without the user thoroughly understanding this manual.
- After disabling safety systems or altering the product.
- With unauthorized accessories.
- Without proper safeguards at the survey site.
- Contrary to applicable laws, rules and regulations.



### CAUTION

TPS receivers should never be used in dangerous environments. Use in rain or snow for a limited period is permitted.

## Battery Pack Warnings



### CAUTION

Never attempt to open the casing of the internal battery! Lithium-Ion batteries can be dangerous if mishandled!



### CAUTION

Do not incinerate or heat battery pack above 185 degrees Fahrenheit (85 degrees Celsius). Excessive heat can cause serious damage and possible explosion.



### CAUTION

Tampering with the internal battery by end users or non-factory authorized technicians will void the battery's warranty.

- Do not attempt to open the battery pack or replace it.
- Do not disassemble the battery pack.
- Do not charge in conditions different than specified.
- Do not use other than the specified battery charger.
- Do not short circuit.
- Do not crush or modify.



### CAUTION

Dispose of the battery in accordance with your local regulations.

## Receiver Warnings

---



### CAUTION

Tampering with the receiver by the end users or non-factory authorized technicians will void the receiver's warranty:

- Do not attempt to open the receiver and modify any of its internal components.
  - Do not charge in conditions different than specified.
  - Do not short circuit.
- 

## Usage Warnings

---



### CAUTION

If this product has been dropped, altered, transported or shipped without proper packaging or otherwise treated without care, erroneous measurements may occur.

The surface of the unit may overheat under maximum operating temperature conditions. Use caution when operating under this condition. No impact on functionality will occur if operating within the temperature limit. See Table 9-1 on page 9-1 for operating temperatures.

The external AC/DC power supply adapter P/N 1005555-01 must not be used above 40°C air temperature.

The owner should periodically test this product to ensure it provides accurate measurements.

Inform TPS immediately if this product does not function properly.

---



# Regulatory

The chapter provides information about this product's compliance with government regulations for use.

## FCC Compliance

This equipment complies with FCC radiation exposure limits set forth for uncontrolled equipment and meets the FCC radio frequency (RF) Exposure Guidelines in Supplement C to OET65. This equipment has very low levels of RF energy that it deemed to comply without maximum permissive exposure evaluation (MPE). But it is desirable that it should be installed and operated with at least 37 cm and more between the radiator and person's body (excluding extremities: hands, wrists, feet and ankles).

This equipment has been tested and found to comply with the limits for a Class A digital device pursuant to part 15 of the FCC rules. These limits are designed to provide reasonable protection against harmful interference when the equipment is operated in a commercial environment. This equipment generates, uses and can radiate radio frequency energy and, if not installed and used in accordance with the instruction manual, may cause harmful interference to radio communications. Operation of this equipment in a residential area is likely to cause harmful interference in which case the user will be required to correct the interference at his own expense.

If this equipment does cause interference to radio or television equipment reception, which can be determined by turning the equipment off and on, the user is encouraged to try to correct the interference by one or more of the following measures:

- Reorient or relocate the receiving antenna.
- Move the equipment away from the receiver.
- Plug the equipment into an outlet on a circuit different from that to which the receiver is powered.
- Consult the dealer or an experienced radio/television technician for additional suggestions



### CAUTION

Any changes or modifications to the equipment not expressly approved by the party responsible for compliance could void your authority to operate such equipment.

---

## ISED Canada Compliance

This class A digital apparatus complies with Canadian ICES-003.

*Cet appareil numérique de la classe A est conforme à la norme NMB-003 du Canada.*

This device complies with ISED Canada license-exempt RSS standard(s). Operation is subject to the following two conditions: (1) this device may not cause interference and (2) this device must accept any interference, including interference that may cause undesired operation of the device.

Le présent appareil est conforme aux CNR d'ISED Canada applicables aux appareils radio exempts de licence. L'exploitation est autorisée aux deux conditions suivantes: (1) l'appareil ne doit pas produire de brouillage, et (2) l'utilisateur de l'appareil doit accepter tout brouillage radioélectrique subi, même si le brouillage est susceptible d'en compromettre le fonctionnement.

CAN ICES-3(A)/NMB-3(A)

# Community of Europe Compliance

The product described in this manual is in compliance with the Radio Equipment Directive (RE-D) and EMC directives from the European Community.

## European Community Declaration of Conformity

European Community Declaration of Conformity with Radio Equipment Directive 2014/53/EU

The following CE mark is affixed to the device:



### CAUTION

This is a Class A product. In a domestic environment this product may cause radio interference in which case the user may be required to take adequate measures.

## Restrictions on Use

The GRX3 UHF radio modem has been designed to operate only at specific frequencies. The exact frequency in use differs from one region and/or country to another. The user of a radio modem must take care that the said device is not operated without the permission of the local authorities on frequencies other than those specifically reserved and intended for use without a specific permit.

The GRX3 UHF (406-470 MHz) is allowed to be used in the following countries, either on license free channels or on channels where the operation requires a license. Additional detailed information is available at the local frequency management authority.



### NOTICE

The countries affected by the GRX3 restrictions in use are: AT, BE, BG, CY, DK, FI, FR, DE, GR, IS, IE, IT, LU, MT, NL, NO, ES, SE, CH, GB, AU, CA, CZ, EE, HU, LV, LT, PL, PT, RO, SI, SK, ZA, TR, HR and US.

## Product Conformity

Hereby, Sokkia declares that the GRX3 radio modem is in compliance with the essential requirements (radio performance, electromagnetic compatibility and electrical safety) and other relevant provisions described in Directive 2014/53/EU.

Therefore, the equipment is labeled with the CE-marking. The operating frequency range of the device is not harmonized throughout the market area and the local spectrum authority should be contacted prior to use.

# Declaration of Conformity (Radio Equipment Directive 2014/53/EU)

esky [Czech]	(Sokkia) tímto prohlašuje, že tento (GRX3) je ve shod se základními požadavky a dalšími příslušnými ustanoveními směrnice 2014/53/ES.
Dansk [Danish]	Undertegnede (Sokkia) erklærer herved, at følgende udstyr (GRX3) overholder de væsentlige krav og øvrige relevante krav i direktiv 2014/53/EF.
Deutsch [German]	Hiermit erkläre (Sokkia) dass sich das Gerät (GRX3) in Übereinstimmung mit den grundlegenden Anforderungen und den übrigen einschlägigen Bestimmungen der Richtlinie 2014/53/EG befindet.
Eesti [Estonian]	Käesolevaga kinnitab (Sokkia) seadme (GRX3) vastavust direktiivi 2014/53/EÜ põhinõuetele ja nimetatud direktiivist tulenevatele teistele asjakohastele sätetele.
English	Hereby, (Sokkia) declares that this (GRX3) is in compliance with the essential requirements and other relevant provisions of Directive 2014/53/EC.
Español [Spanish]	Por medio de la presente (Sokkia) declara que el (GRX3) cumple con los requisitos esenciales y cualesquiera otras disposiciones aplicables o exigibles de la Directiva 2014/53/CE.
Ελληνικά [Greek]	(Sokkia) δια του παρούσα δηλώνει ότι (GRX3) είναι σύμφωνα με τις απαιτήσεις και άλλες σχετικές διατάξεις της οδηγίας 2014/53/EK.
Français [French]	Par la présente (Sokkia) déclare que l'appareil (GRX3) est conforme aux exigences essentielles et aux autres dispositions pertinentes de la directive 2014/53/CE.
Italiano [Italian]	Con la presente (Sokkia) dichiara che questo (GRX3) è conforme ai requisiti essenziali ed alle altre disposizioni pertinenti stabilite dalla direttiva 2014/53/CE.
Latviski [Latvian]	Ar šo (Sokkia) deklar, ka (GRX3) atbilst Direktvas 2014/53/EK btiskajm prasbm un citiem ar to saisttajiem noteikumiem.
Lietuvi [Lithuanian]	Šiuo (Sokkia) deklaruoja, kad šis (GRX3) atitinka esminius reikalavimus ir kitas 2014/53/EB Direktyvos nuostatas.
Nederlands [Dutch]	Hierbij verklaart (Sokkia) dat het toestel (GRX3) in overeenstemming is met de essentiële eisen en de andere relevante bepalingen van richtlijn 2014/53/EG.
Malti [Maltese]	Hawnhekk, (Sokkia), jiddikjara li dan (GRX3) jikkonforma mal-tijiet essenzjali u ma provvedimenti orajn rilevanti li hemm fid-Dirrettiva 2014/53/EC.
Magyar [Hungarian]	Alulírott, (Sokkia) nyilatkozom, hogy a (GRX3) megfelel a vonatkozó alapvető követelményeknek és az 2014/53/EC irányelv egyéb előírásainak.

Polski [Polish]	Niniejszym, ( <i>Sokkia</i> ), deklaruje, że ( <i>GRX3</i> ) spełnia wymagania zasadnicze oraz stosowne postanowienia zawarte w Dyrektywie 2014/53/EC.
Português [Portugues]	( <i>Sokkia</i> ) declara que este ( <i>GRX3</i> ) está conforme com os requisitos essenciais e outras disposições da Directiva 2014/53/CE.
Slovensko [Slovenian]	( <i>Sokkia</i> ) izjavlja, da je ta ( <i>GRX3</i> ) v skladu z bistvenimi zahtevami in ostalimi relevantnimi določili direktive 2014/53/ES.
Slovensky [Slovak]	( <i>Sokkia</i> ) týmto vyhlasuje, že ( <i>GRX3</i> ) spĺňa základné požiadavky a všetky príslušné ustanovenia Smernice 2014/53/ES.
Suomi [Finnish]	( <i>Sokkia</i> ) vakuuttaa täten että ( <i>GRX3</i> ) tyyppinen laite on direktiivin 2014/53/EY oleellisten vaatimusten ja sitä koskevien direktiivin muiden ehtojen mukainen.
Svenska [Swedish]	Härmed intygar ( <i>Sokkia</i> ) att denna ( <i>GRX3</i> ) står i överensstämmelse med de väsentliga egenskapskrav och övriga relevanta bestämmelser som framgår av direktiv 2014/53/EG.

## WEEE Directive

Following information is for EU-member states only:

The use of the symbol below indicates that this product may not be treated as household waste. By ensuring this product is disposed of correctly, to help prevent potential negative consequences for the environment and human health, which could otherwise be caused by inappropriate waste handling of this product. For more detailed information about the take-back and recycling of this product, please contact a supplier where you purchased the product or consult.



## Japan Bluetooth SiteComm Module Compliance

The integrated Bluetooth SiteComm module reference application described on page 61 complies in accordance with the provisions of Article 38-24 paragraph 1 of Japan Radio Law. The certificate granted in accordance with Japan Radio Law has the identifier R 209-J00231 (Bluetooth SiteComm) or R 201-180688.

# Bluetooth Transmission Statements/Compliance

This Bluetooth device is compliant to the following profiles of the core spec version 2.1/2.1+EDR:

- Baseband
- HCI
- Link Manager
- Radio

The radio has been tested using the maximum antenna gain of 2.3 dBi and the Bluetooth qualification is valid for any antenna with the same or less gain.

# Warranty

Sokkia laser and electronic positioning equipment are guaranteed against defects in material and workmanship under normal use and in applications consistent with this Manual. The equipment is guaranteed for the period indicated, on the warranty card accompanying this product and starting from the date that this product is sold to the original purchaser by an Sokkia dealer.<sup>1</sup>

During the warranty period, Sokkia will, at its option, repair or replace this product at no additional charge. Repair parts and replacement products will be furnished on an exchange basis and will be either reconditioned or new. This limited warranty does not include service to repair damage to the product resulting from an accident, disaster, misuse, abuse or modification of the product.

Warranty service may be obtained from an authorized Sokkia warranty service dealer. If this product is delivered by mail, the purchaser agrees to insure the product or assume the risk of loss or damage in transit, to prepay shipping charges to the warranty service location and to use the original shipping container or equivalent. A letter should accompany the package furnishing a description of the problem and/or defect.

The purchaser's sole remedy shall be replacement as described above. In no event shall Sokkia be liable for any damages or other claims including any claim for lost profits, lost savings, or other incidental or consequential damages arising out of the use of, or inability to use, the product.

# Glossary

## B

**BDS**—BeiDou Navigation Satellite System maintained and operated by China. See also, BeiDou.

**Base Station**—A GNSS receiver set up over a known point, which is used to derive correction information for nearby Rover (mobile) GNSS receivers.

**BeiDou**—Navigation Satellite System maintained and operated by China. See also, BDS.

**Bluetooth**—Often used in place of cables, Bluetooth is open wireless technology for exchanging data over short distances from fixed and/or mobile devices.

## E

**Ephemeris Data**—A table or data file showing the calculated positions of a celestial object.

## G

**GALILEO**—The satellite system currently maintained and operated by the European Union (EU) and European Space Agency (ESA).

**GGD**—GPS + GLONASS Dual Frequency signal tracking.

**GNSS**—Global Navigation Satellite System.

**GNSS Receiver**—GNSS Receivers determine the user position, velocity and precise time by processing broadcasted signals from global satellites.

**GLONASS**—The **G**LObal **N**avigation **S**atellite **S**ystem maintained and operated by the Russian Federation.

**GPS**—The **G**lobal **P**ositioning **S**ystem maintained and operated by the United States Department of Defense.

## L

**L1**—The primary L-band carrier used by GPS, GLONASS and QZSS satellites to transmit satellite data.

**L2**—The secondary L-band carrier used by GPS, GLONASS and QZSS satellites to transmit satellite data.

**Light Emitting Diodes (LEDs)**—These LEDs are used as indicator lights on the GRX3 receiver to display the status of the receiver's components and to control receiver operations.

## M

**MAGNET Field**—Field application software used to collect survey mapping data for use by total stations, levels and GNSS receivers.

**MAGNET Office**—Post-processing and CAD solution software for surveying and grade application. It is part of the MAGNET software system.

**MINTER**—The receiver's **M**inimum **I**NTERface used to display and control data input and output.

**N**

**Network Real Time Kinematic (RTK)**—a satellite navigation technique used to enhance the precision of position data derived from satellite-based positioning systems such as GPS, GLONASS, Galileo, BeiDou, QZSS, and NavIC systems.

**O**

**Option Authorization File (OAF)**—This enables the specific features that a customer purchases.

**P**

**Phase Center of Antenna**—The point from which the electromagnetic radiation spreads spherically outward, with the phase of the signal being equal at any point on the sphere.

**Pocket 3D**—Field controller software (made by Topcon) that supports both GNSS and Total Station measurements.

**R**

**Real Time Kinematic (RTK)**—A precise method of real-time surveying. RTK enables you to check the measurement quality without having to process the data.

**Rover**—A mobile GNSS receiver and data collector used for determining field location.

**S**

**Satellite Based Augmentation Systems (SBAS)**—SBAS transmits differential corrections and messages for navigation satellites that are within sight of a network or a reference station in a wide area—such as a continent.

**Sokkia Receiver Utility (SRU)**—Hardware configuration software designed for GNSS receivers and peripheral devices. SRU software can be downloaded from the Sokkia Care site: <https://us.sokkia.com/sokkia-care-products/sru-sokkia-receiver-utility>.

**Static Survey**—Typically uses a network or multiple baseline for positioning. The static survey method provides the highest accuracy and requires the longest observation times.

**U**

**Universal Serial Bus (USB)**—An industry connection standard used by devices, such as a receiver or controller to connect to a computer.



# SOKKIA



Concerns regarding this Sokkia product may be sent to Service and Repair Department,  
Topcon Positioning Systems, Inc., 7400 National Drive, Livermore, California 94550

Specifications subject to change without notice. All rights reserved. 1030371-01, Revision C, 12/2022 © 2022 Topcon Corporation