

SOKKIA

SDL30
SDL50

Digital Level

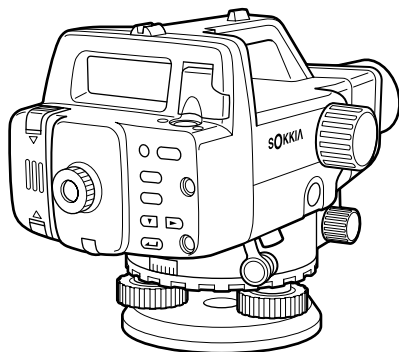

Digital Level **SDL30**
SDL50

OPERATOR'S MANUAL

Thank you for selecting the Digital Level SDL30/50.

- Please read this operator's manual carefully before using this product.
- Verify that all equipment is included. See "20.1 Standard Equipment".
- SDL30/50 has a function to output data saved in SDL30/50 to a connected computer. Commands operations from a computer can also be performed. For details, refer to the "Output Formats and Command Explanations (SDL Edition)" manual and ask your local dealer.
- The specifications and general appearance of the instrument are subject to change without prior notice and without obligation by Sokkia Topcon Co., Ltd. and may differ from those appearing in this manual.
- The content of this manual is subject to change without notice.
- Some of the diagrams in this manual may be simplified for easier understanding.

CONTENTS

Read This First	1. Precautions for Safe Operation	4
	2. Precautions.....	7
Introduction	3. SDL Functions	9
	3.1 Parts of the Instrument and Operation	9
	3.2 Display.....	11
	3.3 Operating Keys.....	15
	3.4 Operating Modes	16
Preliminaries	4. Installing and Removing the Battery	18
	5. Setting Up the Instrument.....	19
	6. Focusing and Sighting	20
Surveying	7. Basic Operation	22
	7.1 Reading the Staff.....	22
	7.2 Measuring in Status Mode.....	25
	7.3 Measuring using Wave-and-Read	26
	8. Setting Up Data Storage.....	29
	8.1 JOB Setting	29
	8.2 Record Conditions	31
	8.3 Double-run Measurement.....	32
	8.4 Flow of Recording Data	32
	9. Measuring Height Difference	36
	10. Measuring Elevation	39
	11. Setting Out Height Difference, Distance, and Elevation.....	42
	11.1 Setting Out Height Difference.....	42
	11.2 Setting Out Distance.....	44
	11.3 Setting Out Elevation.....	45
	12. Other Measurement Functions	48
	12.1 Measuring Horizontal Angle	48
	12.2 Using the Instrument as a Standard Level.....	48

Managing Recorded Data	13. Displaying Recorded Data	49
	13.1 Data Check and Edit	49
	13.2 Number of Recorded Points	50
	14. JOB Delete	51
	15. Sending Recorded Data	53
	15.1 Connecting to a Computer or Data Collector	53
	15.2 Data Output	54
	16. Changing the Settings	56
	16.1 Measuring Mode	56
	16.2 Fractional / Decimal representation of Height Unit	57
Other Procedures	16.3 Communication Parameters	58
	16.4 Auto Power-Off	58
	16.5 Unit of Measurement	59
	17. Warnings and Error Messages	60
	18. Charging the Battery	63
	19. Checks and Adjustments	65
	19.1 Adjusting the Circular Level	65
	19.2 Adjusting the Reticle	66
	20. Equipment and Accessories	72
	20.1 Standard Equipment	72
20.2 Optional Accessory	73	
20.3 Staffs	74	
Specifications	21. Specifications	76
Regulations	22. Regulations	80

1. Precautions for Safe Operation

For the safe use of the product and prevention of injury to operators and other persons as well as prevention of property damage, items which should be observed are indicated in this operator's manual by WARNING and CAUTION indications.

The definitions of the indications are listed below. Be sure you understand them before reading the manual's main text.

Definitions of Indications



WARNING

Ignoring this indication and making an operation error could possibly result in death or serious injury to the operator.



CAUTION

Ignoring this indication and making an operation error could possibly result in minor injury or property damage.

General

Warning

- Do not use voltage other than the specified power supply voltage. Fire or electrical shock could result.
- Do not use the unit in areas exposed to high amounts of dust or ash, in areas where there is inadequate ventilation, or near combustible materials. An explosion could occur.
- Do not perform disassembly or rebuilding. Fire, electric shock or burns could result.
- Never look at the sun through the telescope. Loss of eyesight could result.
- Do not look at reflected sunlight from a prism or other reflecting object through the telescope. Loss of eyesight could result.

Caution

- Do not use the carrying case as a footstool. The case is slippery and unstable so a person could slip and fall off it.
- Do not place the instrument in a case with a damaged catch, belt or handle. The case or instrument could be dropped and cause injury.

Staff

Warning

- Do not use under thunderous weather conditions. This unit is conductive and if struck by lightning, death or injury could result.
- Handle with care when using near high voltage cables or transformers. This unit is conductive and contact could result in electric shock.

Tripod

Caution

- When mounting the instrument to the tripod, tighten the centering screw securely. Failure to tighten the screw properly could result in the instrument falling off the tripod, causing injury.
- Tighten securely the leg fixing screws of the tripod on which the instrument is mounted. Failure to tighten the screws could result in the tripod collapsing, causing injury.
- Do not carry the tripod with the tripod shoes pointed at other persons. A person could be injured if struck by the tripod shoes.
- Keep hands and feet away from the tripod shoes when fixing the tripod in the ground. A hand or foot stab wound could result.
- Tighten the leg fixing screws securely before carrying the tripod. Failure to tighten the screws could lead to the tripod legs extending, causing injury.

Power Supply

Warning

- Use only the specified battery charger to recharge batteries. Other chargers may be of different voltage rating or polarity, causing sparking which could lead to fire or burns.
- Do not place articles such as clothing on the battery charger while charging batteries. Sparks could be induced, leading to fire.
- Do not use damaged power cords, plugs or loose outlets. Fire or electric shock could result.
- Do not use batteries or the battery charger if wet. Resultant shorting could lead to fire or burns.

- To prevent shorting of the battery in storage, apply insulating tape or equivalent to the terminals. Otherwise shorting could occur resulting in fire or burns.
- Do not heat or throw batteries into fire. An explosion could occur, resulting in injury.
- Do not connect or disconnect power supply plugs with wet hands. Electric shock could result.

**Caution**

- Do not touch liquid leaking from batteries. Harmful chemicals could cause burns or blisters

2. Precautions

Using the Instrument

- The SDL30/50 is a precision instrument. Avoid severe shocks or vibration.
- Be careful when removing the instrument from its case.
- Do not place the SDL30/50 directly on the ground.
- When the operator leaves the SDL30/50, the vinyl cover should be placed on the instrument.
- Never carry the SDL30/50 on the tripod to another site.
- Always turn the instrument off and remove the battery before storing the instrument in its case.
- When the instrument is placed in the carrying case, see "20.1 Standard Equipment".
- Always wipe off moisture and dirt adhering to the instrument during survey work. Moisture or dirt on the lens may result in incorrect readings.
- Consult your local dealer before using the instrument under special conditions such as long periods of continuous use or high levels of humidity. In general, special conditions are treated as being outside the scope of the product warranty.

Maintenance

- Always clean the instrument before returning it to the case. The lens requires special care. Dust it off with the lens brush first, to remove tiny particles. Then, after providing a little condensation by breathing on the lens, wipe it with the supplied cleaning cloth or lens tissue.
- If the display is dirty, carefully wipe it with a soft, dry cloth. To clean other parts of the instrument or the carrying case, lightly moisten a soft cloth in a mild detergent solution. Wring out excess water until the cloth is slightly damp, then carefully wipe the surface of the unit. Do not use any organic solvents or alkaline cleaning solutions.
- Store the instrument and accessories in a dry room where the temperature remains fairly constant.
- If any trouble is found with the screws or optical parts (e.g. lens), contact your local dealer.

- Always close the case when empty to protect the interior from humidity and dust.
- Regular checking and adjustment is recommended to maintain instrument precision.

Exceptions from responsibility

- The user of this product is expected to follow all operating instructions and make periodic checks (hardware only) of the product's performance.
- The manufacturer, or its representatives, assumes no responsibility for results of faulty or intentional usage or misuse including any direct, indirect, consequential damage, or loss of profits.
- The manufacturer, or its representatives, assumes no responsibility for consequential damage, or loss of profits due to any natural disaster, (earthquake, storms, floods etc.), fire, accident, or an act of a third party and/or usage under unusual conditions.
- The manufacturer, or its representatives, assumes no responsibility for any damage (change of data, loss of data, loss of profits, an interruption of business etc.) caused by use of the product or an unusable product.
- The manufacturer, or its representatives, assumes no responsibility for any damage, and loss of profits caused by usage different to that explained in the operator's manual.
- The manufacturer, or its representatives, assumes no responsibility for damage caused by incorrect operation, or action resulting from connecting to other products.

3. SDL Functions

Important:

- Except where stated, screens and illustrations appearing in this manual are of SDL30/50.
- In principle, screens used in procedures are based on the factory setting.

3.1 Parts of the Instrument and Operation

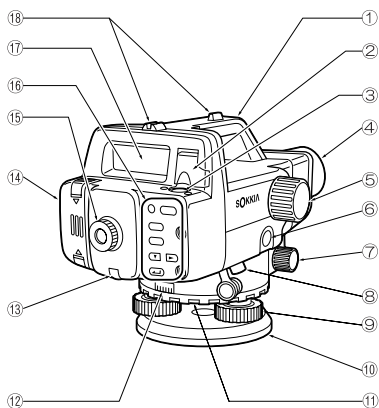

- ① Handle
- ② Bubble mirror
When the instrument is placed high up and cannot be viewed from above, you can use the mirror to check the position of the bubble in the tube.
- ③ Circular level
- ④ Objective lens
- ⑤ Focusing knob
Use this knob to focus on the staff.

- ⑥ Measure key (appears as **Measure** in this manual)
Starts measurement.
(See "3.3 Operating Keys".)
- ⑦ Horizontal fine motion knobs (both sides)
Use these knobs to finely adjust the instrument's horizontal position.
- ⑧ Data output connector
You can connect a data collector or computer to this connector.
- ⑨ Leveling foot screw
- ⑩ Base plate
- ⑪ Horizontal circle positioning ring
You can rotate the horizontal scale while the instrument is fixed in position. Use to align benchmarks with '0', etc.
- ⑫ Horizontal circle
- ⑬ Reticle adjusting screw and screw cover
Use this screw to mechanically adjust the reticle.
- ⑭ Battery cover
- ⑮ Eyepiece
Adjust the reticle focus to suit your eyesight.
- ⑯ Keyboard (See "3.3 Operating Keys".)
- ⑰ Display (See "3.2 Display".)
- ⑱ Gunsight
Use for coarse adjustment of the orientation of the instrument.

3.2 Display

The display includes the following marks which indicate the operating status and current mode, and help the operator to keep track of the measurement procedure.

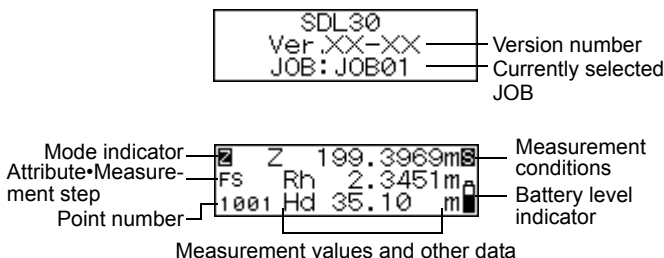

- **Point number display**

The next point number to be recorded is displayed.

- **Mode display**

The displayed mark shows the current mode.

- M** : Status mode or Measurement mode
- M** : Menu mode
- JOB** : JOB setting mode
- REC** : Record setting mode
- ZH** : Height difference measurement mode
- Z** : Elevation measurement mode
- SO** : Setting out mode
- C** : Configuration mode
- Rev.** : Data review menu

- **Attribute•Measurement step display**

Displays the backsight and foresight (in Height difference, Setting out, or Measuring elevation modes).

BS : Backsight

FS : Foresight

Displays the attribute of the recorded measurement value (Height difference measurement mode, Elevation measurement mode).

BS : Backsight point

FS : Foresight point

IS : Intermediate sight

FIX : Fixed point

Off : Off

Displays the measurement step (when Adjustment is selected in the Configuration mode).

At position A

Aa1 : Take a reading on staff a.

Ab1 : Take a reading on staff b.

Aa2 : Take a reading on staff a with the tripod turned 180°.

Ab2 : Take a reading on staff b with the tripod turned 180°.

At position B

Ba1 : Take a reading on staff a.

Bb1 : Take a reading on staff b.

Ba2 : Take a reading on staff a with the tripod turned 180°.

Bb2 : Take a reading on staff b with the tripod turned 180°.

Displays the page number of the active menu (when the Menu mode or Configuration mode is selected).

P1 : First page

P2 : Second page

- **Measuring mode (not displayed on menu screens)**

Displays the currently selected measuring mode.

S : Single measurement

A : Average measurement





W : Wave-and-Read measurement

R : Repeat measurement

T : Tracking measurement

- **Battery level (not displayed on menu screens)**

Displays the current power level of the battery.

-  : Level 3: Full power.
-  : Level 2: Plenty of power remains.
-  : Level 1: Half or less power remains.
-  : Level 0: Little power remains. Charge the battery.
-  : Low: No power remains (A beep tone sounds and the battery symbol blinks.) Charge the battery. Operation cannot be performed. After a short time the instrument automatically powers off.





- **Measurements**

The following symbols are displayed.





- Rh : Staff reading (height)
- Hd : Horizontal distance to staff
- ΔH : Height difference
- Z : Elevation

The fractional/decimal display format for measurement value, calculation value and input value depends on the settings in measuring mode and fractional/decimal representation of height units. (See "16. Changing the Settings".)

- When the fractional/decimal display format is set to "0.0001m" and the unit of measurement is "m", the display is as follows:

	Z	41.7210m	
Fs	Rh	1.7420m	
2001	Hd	35.09 m	

When measuring mode is "Single", "Average" or "Repeat"
 Height: Up to 4 decimals
 Distance: Up to 2 decimals

	Z	41.721 m	
Fs	Rh	1.742 m	
2001	Hd	35.1 m	

When measuring mode is "Tracking"
 Height: Up to 3 decimals
 Distance: Up to 1 decimal

- When the fractional/decimal display format is set to "0.001m" and the unit of measurement is "m", the display is as follows:

Z	41.721	m
Fs	Rh	1.742
2001	Hd	35.09

When measuring mode is "Single", "Average" or "Repeat"

Height: Up to 3 decimals

Distance: Up to 2 decimals

Z	41.72	m
Fs	Rh	1.74
2001	Hd	35.1

When measuring mode is "Tracking"

Height: Up to 2 decimals

Distance: Up to 1 decimal

- When the fractional/decimal display format is set to "0.001ft" and the unit of measurement is "ft", data is displayed as follows:

When measuring mode is "Single", "Average" or "Repeat"

Height: Up to 3 decimals

Distance: Up to 1 decimal

When measuring mode is "Tracking"

Height: Up to 2 decimals

Distance: 0 decimal

- When the fractional/decimal display format is set to "0.01ft" and the unit of measurement is "ft", data is displayed as follows:

When measuring mode is "Single", "Average" or "Repeat"

Height: Up to 2 decimals

Distance: Up to 1 decimal

When measuring mode is "Tracking"

Height: Up to 1 decimal

Distance: 0 decimal

- When the fractional/decimal display format is set to "1/8" and the unit of measurement is "inch", the display is as follows:

Z	654-02-1/4	in
Fs	Rh	7-08-3/8
2001	Hd	115-02

When measuring mode is "Single", "Average" or "Repeat"

Height: **-**-*/₈

Distance: **-**-**

Z	654-02-1/4	in
Fs	Rh	7-08-3/8
2001	Hd	115

When measuring mode is "Tracking"

Height: **-**-*/₈

Distance: **-**-**

Note:

- The fractional/decimal display format for distance measurements depends on the setting in measuring mode only.

3.3 Operating Keys

Learn main key operations here.

- **Power ON/OFF**

 : Power the instrument ON



 (hold) +  : Power the instrument OFF

- **Light up the display**

 : Switch the display backlight ON / OFF



- **Measurement start / stop**

 : Start measurement

 /  : Stop measurement (in repeat, average or tracking mode)

 : Cancel measurement

- **Select / cancel (return to former procedure) menus and options**

 /  : Scroll to next position (JOB selection, item selection, etc.)

 : Accept the option

 : Enter Menu mode

 : Return to former procedure or to Status mode

- **Value input / cancel**

 : Advance the numeral
Toggle the +/- sign

 : Change the position of the inverted cursor

 : Accept the input value

3.4 Operating Modes

The SDL has a number of functional modes. This section shows the screens that can be displayed in each mode.

Ⓐ : Key operation for selecting each menu

Ⓑ : Key operation for returning to previous screen

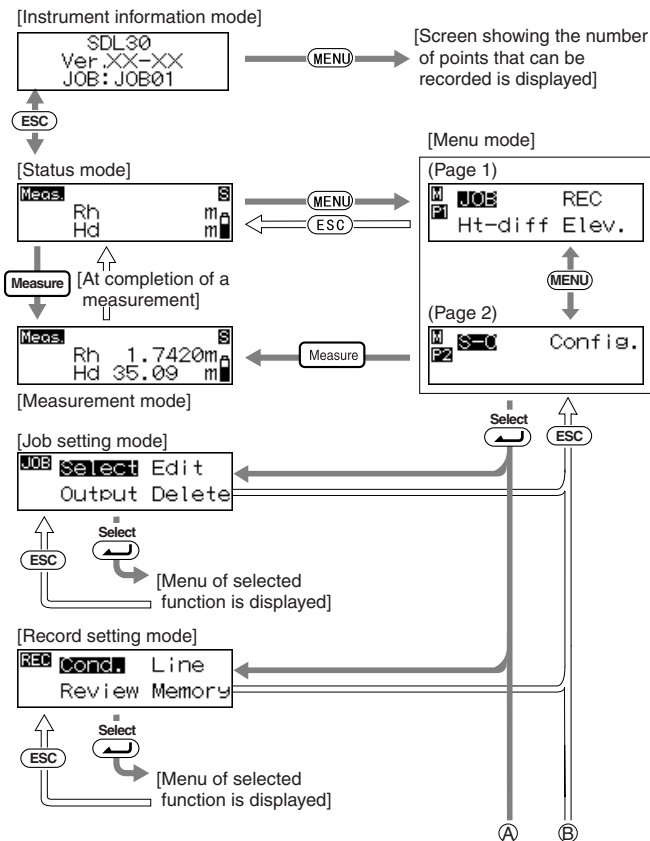

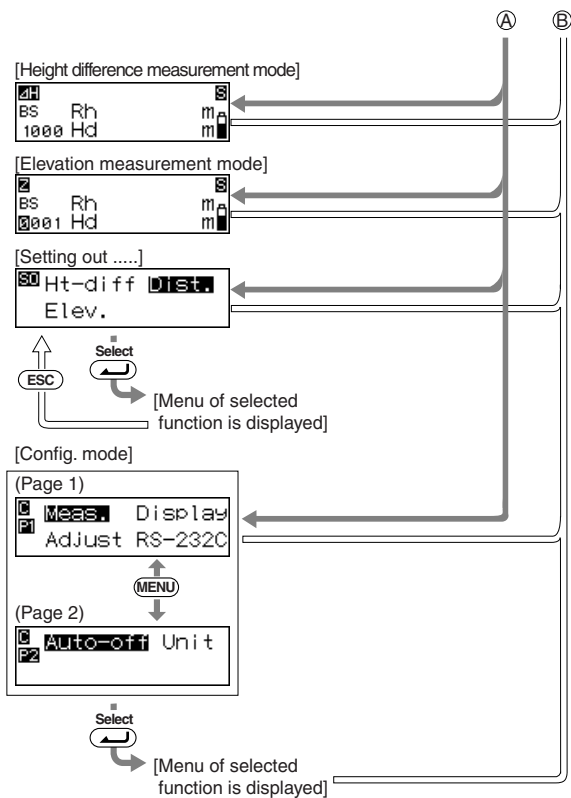

4. Installing and Removing the Battery

Install a fully-charged battery (see "18. Charging the Battery").

Procedure

1

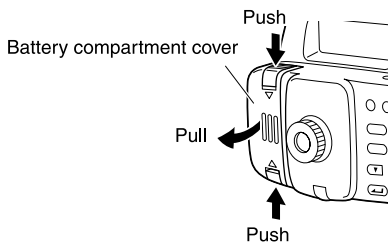

2

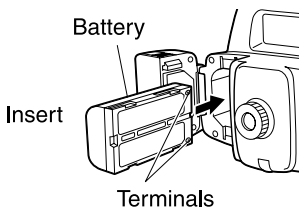

3

Push until
a click is
heard

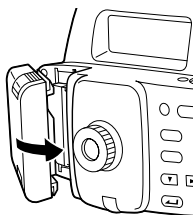

Important:

- Always turn off the power before removing the battery from the instrument. If the battery is removed when the power is still on, stored data may be lost.

5. Setting Up the Instrument

Procedure

- 1 Set up the tripod.

Spread the tripod legs about the same distance apart so that the tripod head is approximately level. Tread the tripod shoes firmly into the ground.

- 2 Mount the instrument on the tripod.

Hold the instrument on the tripod head and tighten the centering screw.

- 3 Level the instrument.

Spherical head tripod: Loosen the centering screw and slide the instrument across the tripod head until the bubble is centered in the circular level. Tighten the centering screw.

Flat head tripod: Extend or push in the tripod legs until the bubble is centered in the circular level. When the bubble is more or less centered, turn the leveling foot screws until the bubble is exactly centered in the circle. When you turn a screw clockwise, raising the instrument, the bubble will move toward the position of that screw.

6. Focusing and Sighting

- **Before using the instrument**

Turn the eyepiece to adjust the eyepiece image.

Procedure

- 1 Using the gunsight, aim the objective lens toward the staff.
- 2 Gradually turn the eyepiece outward, stopping just before the reticle cross-lines become blurred.

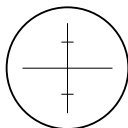

- 3 Turn the horizontal fine motion knobs until the staff is nearly centered in the field of view, then turn the focusing knob to focus on the staff.

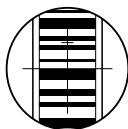

- 4 Looking through the telescope, shift your eyes slightly up and down and to each side.
- 5 If the staff and reticle show no deviation, the instrument is ready for use.
If the staff and reticle deviate, return to step 2.

Important:

- If deviation occurs at step 5, errors will occur when taking measurements. Always make sure the instrument is correctly focused.

- **Focusing when taking measurements**

Procedure

- 1 Using the gunsight, aim the objective lens toward the staff.
- 2 Turn the horizontal fine motion knobs until the staff is nearly centered in the field of view, then turn the focusing knob to focus on the staff.

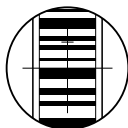

Important:

- If the staff barcodes are out of focus, they will not be readable and measurements cannot be taken. Make sure they are correctly focused.

7. Basic Operation

7.1 Reading the Staff

Simply focus on the RAB* code for an automatic reading of the staff. The following explains how to read the RAB code of the staff.

* : RAB code (Random Bi-directional code) is a coded staff used with SOKKIA digital levels.

Important:

- Set up the staff in an area free of obstacles.
Avoid placing the staff next to mirror-like surfaces. The effect of strong light could make measurement impossible.
- Support the staff so that it is perpendicular, checking the circular bubble scope on the staff. If the staff is tilting, height and distance measurements will be incorrect.
- If the surface is catching the light, turn it just enough to stop the reflection.

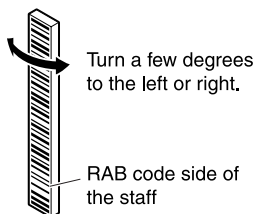

- Make sure shadows are not cast on the staff as this could make measurement impossible.
- When holding the staff during measurement, make sure your hand does not cover the RAB code.
- If dark locations make measurement difficult, shine a flashlight on the staff. Stand at a distance so that the beam shines evenly over the length of the staff.

(Continued on next page)

(Continued from previous page)

- If waterdrops or dirt adhere to the barcode, measurement may be impossible. Wipe the staff clean with a soft cloth.
- Clean the staff if grit or dirt gets stuck between the sections. If the staff is dirty, measurements will not be very accurate.
- Avoid scratching or soiling the barcode surface as this could make measurement impossible. Store and carry the staff inside its case.
- If the BGS series staff is used for leveling, and the height difference and temperature difference are much larger than normal, temperature variations may cause the staff to expand or contract and cause differences in relative height measurements. SDL30/50 reads in measurements up to 0.1mm and minor deviations in the accuracy of the staff will adversely affect accuracy. To obtain high accuracy measurements, it is important to perform temperature corrections for the staff. (See the Note below for details.)

- **Setting up the staff**

Procedure

- 1 Connect the staffs correctly by making sure the numbers on the numeric scale side of the staffs run in unbroken order.
- 2 Set the foot plate on the ground so that the staff will not sink.
- 3 Keeping an eye on the circular bubble scope on the staff, set the staff in the foot plate so that it stands up straight.
- 4 Turn the barcode scale toward the instrument.

- **Measuring the height from a ceiling**

Important:

- Not possible with Wave-and-Read function. Attempting such measurement with the Wave-and-Read function will result in an error.

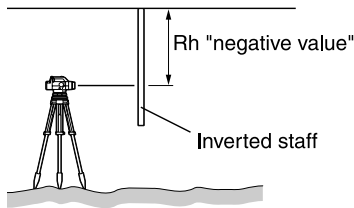

Note:

Formula for correcting expansion and contraction of the staff due to temperature changes

$$\Delta C = \{C_0 + (T - T_0) \times \alpha\} \times \Delta h$$

ΔC : Staff correction value

C_0 : Scale factor

T : Measured temperature during observation (average temperature during measurement of known site, intermediate site, new site)

T_0 : Reference temperature of 20° C

α : Line expansion coefficient

(BGS series : $20 \times 10^{-6} \text{ 1/}^\circ\text{C}$)

Δh : Height difference

7.2 Measuring in Status Mode

In status mode you can sight point A, take the staff reading (Rh), and measure the horizontal distance (Hd) to the staff.

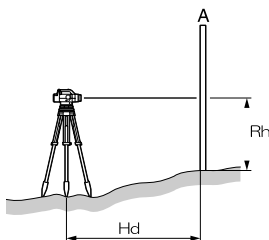

Important:

- During measurement, if direct sunlight or strong light enters the eyepiece and measurement cannot be performed, "Measurement error" or "Too bright" is displayed (see "17. Warnings and Error Messages"). Shield the eyepiece from the light source using your body or cover the eyepiece with your hand and resume measurement.
- If the SDL30/50 is subjected to shocks or vibration during use, measurement may be impossible. Resume measurement during more stable conditions.



The procedure below is for taking single measurements. For repeat measurements, see the notes.

Procedure

Meas.		S
Rh	1.7420m	
Hd	35.09 m	

- 1 Turn the power switch on.
- 2 Focus on the staff and press **Measure**.
Operation starts and the display blinks while measurements are being taken. When measurement is completed, the staff readings (Rh) and horizontal distance (Hd) are displayed.

Note:

- In Repeat, Average, or Tracking mode:
Step 2: Values are renewed at each measurement.
Press  or  to stop the reading.
Press  to cancel the reading.

7.3 Measuring using Wave-and-Read

The Wave-and-Read function reduces measurement error due to the staff not being vertical (i.e. tilting). It also allows measurement using a staff not equipped with a bubble scope.

Wave-and-Read can be used to take the staff reading (R_h), and measure the horizontal distance (H_d) to the staff.

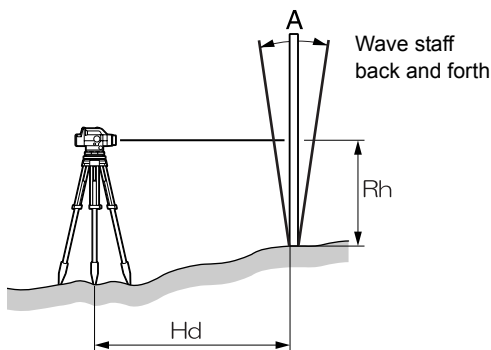

The forward and backward movement with respect to vertical position A should be equal and not in excess of 5 to 10°.

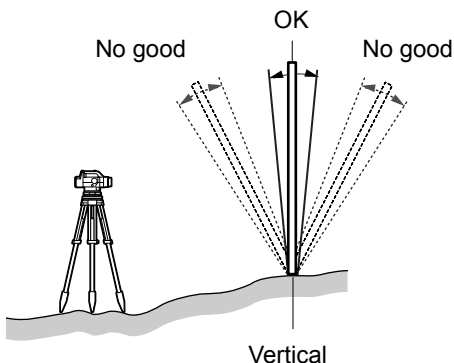

Procedure



- 1 Turn the power switch on.
- 2 Set measuring mode to "Waving".
(see "16.1 Measuring Mode")
- 3 Focus on the staff.
- 4 Wave the staff backwards and forwards (5 to 10°) through the vertical position. Waving speed should be equivalent to 3 passings of the staff through the vertical position in approximately 3 seconds.

Meas.	Rh	1.7420m	W
	Hd	35.9	m

- 5 Press **Measure** to start measurement.

A beep tone sounds and the display blinks. Consecutive arrows are displayed to indicate the progress of measurement.

When measurement is completed, a beep tone sounds twice and the staff readings (Rh) and horizontal distance (Hd) are displayed.

Important:

- During measurement, if direct sunlight or strong light enters the eyepiece and measurement cannot be performed, "Measurement error" or "Too bright" is displayed (see "17. Warnings and Error Messages"). Shield the eyepiece from the light source using your body or cover the eyepiece with your hand and resume measurement. Conversely, measurement cannot be performed when light conditions are too dark.
- Measurement cannot be performed when the staff is waved too fast.
- Measurement cannot be performed when the staff is waved from side to side (left to right). "Measurement error" is displayed (see "17. Warnings and Error Messages").

8. Setting Up Data Storage

Data can be stored in Height difference measurement mode or Elevation measurement mode. JOB setting mode and record setting mode must be set up before data can be recorded.

JOB setting mode

```
JOB Select Edit
      Output Delete
```

Record setting mode

```
REC Cond. Line
      Review Memory
```

Notes:

- *: Factory setting
- Settings are saved even after the instrument is turned off.
- Up to 2000 points can be registered. If 2000 points have already been recorded, a beep tone sounds twice and the number of free points remaining is displayed as "0". Measurement results are not recorded. Press any button to return to the previous screen.
- See "15.2 Data Output" and "14. JOB Delete" for how to "Output" and "Delete" in the JOB setting mode.
- See "13. Displaying Recorded Data" for how to use "Review" and "Memory" in the Record setting mode.

8.1 JOB Setting

Set the JOB containing the measurement data to be recorded. Select from *JOB01 to JOB20.

Notes:

- Between 1 and 12 characters can be set for the JOB name.
- If measurement data has already been saved in the selected JOB, the unit of measurement (m or ft) cannot be changed. The same unit of data will be applied in the future to data that is saved to the same JOB.
- JOB names already used cannot be set.

- **JOB Selection**

Procedure

```
JOB Select Edit
      Output Delete
```

- 1 In the menu mode, select "JOB," and then select "Select."

The currently selected JOB and number of data recorded in the JOB are displayed.



```
JOB: JOB01
Registered: 0123*
```

- 2 Select the JOB you will store the data to.

- 3 Press  to confirm the selected JOB.

Note:

- **JOB Quick Access**

Step 2: When JOB numbers 1 to 10 are displayed, press  to jump to JOB number 11. When JOB numbers 11 to 20 are displayed, press  to jump back to JOB number 1.

- **Changing the JOB name**

Procedure

```
JOB Select Edit
      Output Delete
```

- 1 In menu mode, select "JOB" and then "Edit."

The currently selected JOB name is displayed and can now be edited.

The characters that can be input are shown below. Each time  is pressed, the cursor jumps to the first character of each row shown below.

0 1 2 3 4 5 6 7 8 9
A B C D E F G H I J
K L M N O P Q R S T
U V W X Y Z . + -

Example: Displaying the word AT

JOB: **A**OB01

- 2 Press **(MENU)** four times to display "A."

JOB: **AT**OB01

- 3 Press **(▶)** to move the cursor to the next character.

JOB: **AT**

- 4 Press **(▼)** five times to display "T."

- 5 When the word has been input, press **(↵)** to record the JOB name.

8.2 Record Conditions

Select the method for recording measurement data.
In the menu mode, select "REC," and then "Cond."

* Manual: When measurement is completed, check and record the data

Auto: Data is automatically recorded for foresight point measurements (check and record backsight point measurements manually)

Off: Data cannot be recorded.

8.3 Double-run Measurement

You can set single-run or double-run measurement data as additional information. When data is sent, you can distinguish single-run from double-run measurement data.

In menu mode, select "REC" and then "Line."

* Go: Record sent data

Return: Record returned data

Note:

When "Return" is selected, "*" is displayed in front of measurement value Rh.

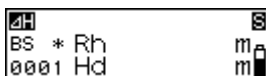

The screenshot shows a rectangular display with a black border. The top-left corner has a small icon of a staff and level. The top-right corner has a small icon of a staff and level. The main display area contains two lines of text: "BS * Rh" on the first line and "0001 Hd" on the second line. To the right of the text, there are two vertical bars, one above the other, representing measurement scales.

8.4 Flow of Recording Data

The following explains the flow of recording measurement data. When using the numerical scale side of the staff and not the RAB code, manually input the measurement data.

A detailed explanation is provided below for items indicated by a *.

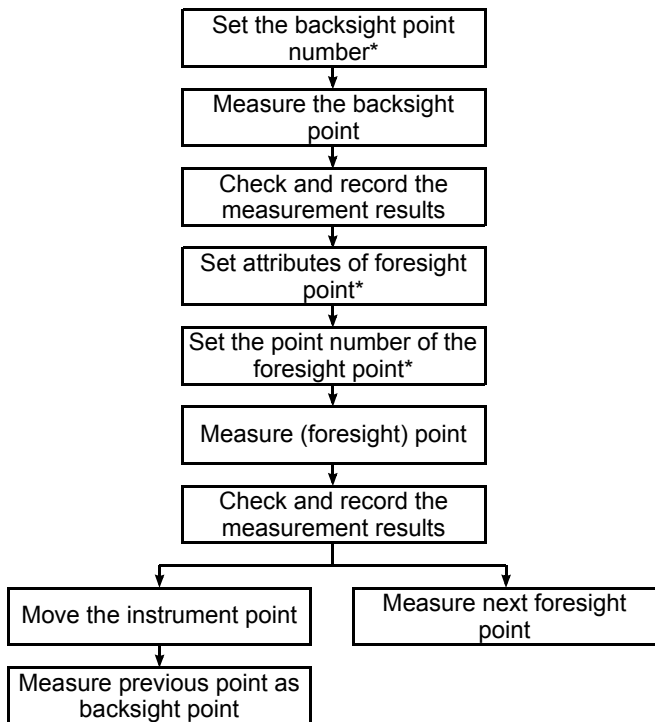

The following procedure is an example of measurement in height difference measurement mode.

- **Setting the point number**

Procedure

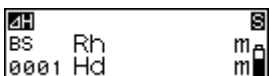

- 1 Press when measuring the backsight point.
The point number can now be set.

ΔH		mS
BS	Rh	m
0001	Hd	m

2 Set the point number.

3 Press  to confirm the point number.

Notes:

Advancing the point number

If the point number is not set, data is recorded using the automatically set number in the currently selected JOB. Check the measurement results together with the point number. Point number is displayed as follows:

- First record after power is switched ON • No data stored in JOB... 0001
- First record after power is switched ON • Data stored in JOB... point number of last measurement point
- Second or later record after power is switched ON • turning point...point number of last measurement point
- Second or later record after power is switched ON • No turning point...point number of last measurement point +1

• Setting attribute (only foresight)

Procedure



ΔH	ΔH	mS
FS	Rh	m
1001	Hd	m

1 Press  when measuring the foresight point.

The attribute can now be set.

ΔH	ΔH	mS
FS	Rh	m
1001	Hd	m

2 Set the attribute.

Each time  or  is pressed: IS (intermediate sight) → FIX (fixed point) → Off → FS (foresight) → IS (intermediate sight)

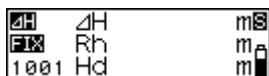

- 3 Press  to confirm the selected attribute.

The point number can now be set. (See "Setting the point number".)

Note:

If the attribute is not set, a point other than the backsight point is recorded as the foresight point.

- **Inputting measurement data (measure the point using the numerical scale side of the staff)**

Procedure

- 1 Focus the SDL30/50 on the numerical scale side of the staff and measure the backsight point.

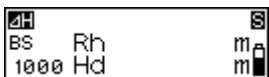

- 2 Press .

Measurement data can now be input manually.

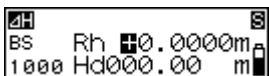

- 3 Input the measurement value found in step 1.

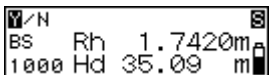

- 4 Check the point number and press "Yes" to record the selected data.

- 5 Measure the next point.

9. Measuring Height Difference

You can measure the height difference ΔH between the backsight (point A) and foresight (point B).

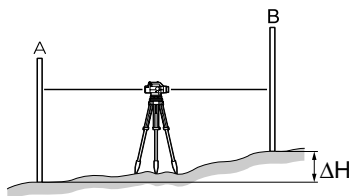

The procedure below is for taking single measurements when "manual" is selected in the Record conditions menu.

Important:

- When moving the instrument to a new position (step 8 below), press "Yes" to save the turning point before switching off the power.

Procedure

- 1 Set up the instrument midway between points A and B.
- 2 In menu mode, select "Ht-diff".
- 3 Measure the backsight.
- 4 Select "Yes" to accept the point number attribute and measurement value.

M	JOB	REC
P1	Ht-diff	Elev.

Y/N		S
BS	Rh 1.7420m	
1000	Hd 35.09 m	

No.1000 Recorded
Free:0998

The result is saved and the number of points that can be recorded in available memory is displayed.

ΔH	ΔH	m
FS	Rh	m
1001	Hd	m

- 5 Measure the foresight.

The instrument calculates the height difference ΔH relative to the backsight, and displays the result.

Y/N	ΔH	-0.6031m
FS	Rh	2.3451m
1001	Hd	35.10 m

- 6 Select "Yes" to accept the point number, attribute and measurement value.

The result is saved.

- 7 Press **(MENU)**.

A message asks whether you want to change the instrument position.

ΔH	Turning Point	
FS		
1002	Yes/No?	

- 8 If moving the instrument, select "Yes". In step 5, the measured foresight is recorded as turning point (TP) height difference.

ΔH	ΔH	m
BS	Rh	m
1001	Hd	m

- 9 Transfer to the next instrument position and repeat the measurements from step 3.

The height difference measured at step 5 is displayed as the height difference of the backsight (TP).

Notes:

- Point number input

Step 3: Press  to ready the instrument for point number input.

Step 5: Press  twice to ready the instrument for point number input.
(See "8.4 Flow of Recording Data".)

- Attribute setting

Step 5: Press  to ready the instrument for attribute setting. (See "8.4 Flow of Recording Data".)

- Go and Return setting

Step 3: Press  to display the Go and Return Setting Screen. (See "8.3 Double-run Measurement".)

- Reviewing stored data

Steps 3 and 5: Press  to display the contents of the selected JOB. (See "13.1 Data Check and Edit".)

- Manually inputting measurement data

Steps 3 and 5: Press . Measurement data can now be input manually. (See "8.4 Flow of Recording Data".)

10. Measuring Elevation

From a known elevation (point A), you can measure the elevation ($HA + \Delta H$) of a specified ground point (point B).

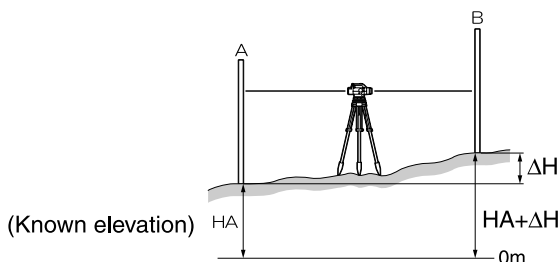

The procedure below is for taking single measurements when "Manual" is selected in the Record conditions menu.

Important:

- When moving the instrument to a new position (step 9 below), press "Yes" to save the Turning Point before switching off the power.

Procedure

- 1 Set up the instrument between points A and B.
- 2 In menu mode, select "Elev."
- 3 Input the backsight elevation.
- 4 Measure the backsight.

M	JOB	REC
P1	Ht-diff	Elev.

☑	Input Elev.	S
BS	Z	0199.3969m

Y/N Rh 1.7420m
1000 Hd 35.09 m

No.1000 Recorded
Free:0998

Z Rh m
Fs Hd m

Y/N Z 199.3969m
Fs Rh 2.3451m
1001 Hd 35.10 m

Turning Point
Fs Yes/No?

Input Elev. S
BS Z 0199.3969m

- 5 Select "Yes" to accept the point number and measurement value.

The result is saved and the number of points that can be recorded in available memory is displayed.

- 6 Measure the foresight.

The instrument calculates the foresight elevation (Z), and displays the result.

- 7 Select "Yes" to accept the point number, attribute and measurement value.

The result is saved.

- 8 Press **MENU**.

A message asks whether you want to change the instrument position.

- 9 If moving the instrument, select "Yes".

In step 6, the measured foresight is recorded as turning point (TP) elevation.

- 10 Transfer to the next instrument position and repeat the measurements from step 3.

The elevation measured at step 6 is measured as the elevation of the backsight (TP).

Notes:

- Point number input

Step 4: Press  to ready the instrument for point number input.

Step 6: Press  twice to ready the instrument for point number input. (See "8.4 Flow of Recording Data".)

- Attribute setting

Step 6: Press  to ready the instrument for attribute setting. (See "8.4 Flow of Recording Data".)

- Go and Return setting

Step 4: Press  to display the Go and Return Setting Screen. (See "8.3 Double-run Measurement".)

- Storing backsight elevation

Steps 3 and 10: Even after power off, backsight elevation is stored or turning point is stored as the next backsight elevation. Since this value is the same as the value in the setting out elevation mode, the backsight elevation is stored to whichever mode is set last. (See "11.3 Setting Out Elevation".)

- Reviewing stored data

Steps 4 and 6: Press  to display the contents of the selected JOB. (See "13.1 Data Check and Edit".)

- Manually inputting measurement data

Steps 4 and 6: Press . Measurement data can now be input manually. (See "8.4 Flow of Recording Data".)

11. Setting Out Height Difference, Distance, and Elevation

You can locate ground points that correspond to entered numerical data. The Set-Out menu provides three modes - height difference, distance, and elevation.

11.1 Setting Out Height Difference

By entering the height difference (ΔH) from a benchmark (point A), you can find a ground point (point B) at a specified height difference from the benchmark.

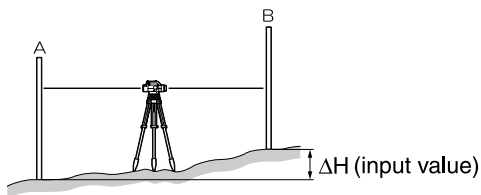

The procedure below is for taking single measurements.

Procedure

- 1 Set up the instrument between points A and B.

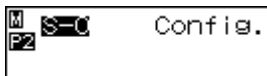

- 2 In menu mode, select "Set-out", then select "Ht-diff".



- 3 Input the height difference value that you want to stake out.

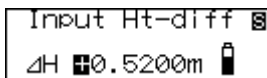

- 4 Measure the backsight.
The instrument takes the backsight reading and displays the measurement.

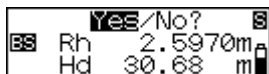

- 5 Select "Yes" to accept the value.

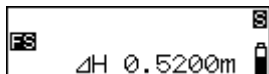

- 6 Measure the foresight.
The instrument calculates the difference between the measurement and the input value, and displays the result.

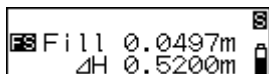

- 7 Move the staff by the amount shown on the screen, then take another foresight reading.

If "Fill" is displayed, move the staff upward.

If "Cut" is displayed, move the staff downward.

When the display shows '0', you have found the specified ground point.

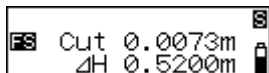

- 8 Press  or .

Height difference set-out is completed.
Set out the next ground point.

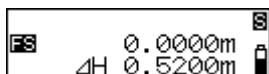

Notes:

- When in this menu and setting-out has already been taken (for the second or subsequent reading):
Step 4: The previous backsight measurement will be displayed and the program skips to step 5.
- Storing setting out height difference:
Step 3: Even after power off, the height difference is stored.

11.2 Setting Out Distance

By entering the distance (Hd) from a benchmark (point A), you can find a ground point (point B) at a specified distance from the benchmark.

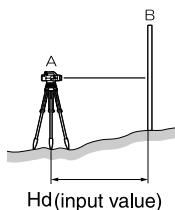

The procedure below is for taking single measurements.

Procedure

- 1 Set up the instrument at point A.
- 2 In menu mode, select "Set-out", then select "Dist."

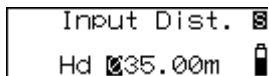
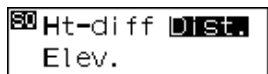
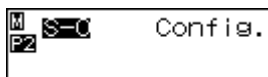

- 3 Input the distance that you want to stake out.

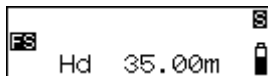

- 4 Measure the foresight.
The instrument calculates the difference between the measurement and the input value, and displays the result.

FS	Out	1.79m	S
	Hd	35.00m	

FS	In	0.08m	S
	Hd	35.00m	

FS		0.00m	S
	Hd	35.00m	

5 Move the staff by the amount shown on the screen, then take another foresight reading.

If "Out" is displayed, move the staff backward.

If "In" is displayed, move the staff forward.

When the display shows '0', you have found the specified ground point.

6 Press \leftarrow or (ESC).

Distance set-out is completed. Set out the next ground point.

Note:

- Storing setting out distance

Step 3: Even after power off, distance is stored.

11.3 Setting Out Elevation

By entering the elevation ($HA + \Delta H$) from a known benchmark (point A), you can find a ground point (point B) at a specified elevation.

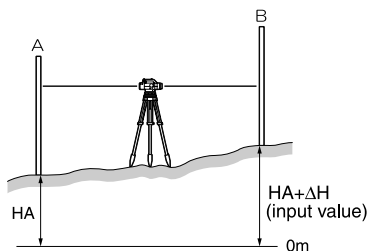

The procedure below is for taking single measurements.

Procedure

M S-O Config.
P2

SO Ht-diff Dist.
Elev.

Input Elev.
BS Z +0041.7210m

Yes/No? S
BS Rh 2.5970m
Hd 30.68 m

Input Elev. S
FS Z +0041.0000m

FS Z 41.6800m

FS Fill 0.0490m
Z 41.6800m

FS Cut 0.0070m
Z 41.6800m

- 1 Set up the instrument midway between points A and B.
- 2 In menu mode, select "Set-out", then select "Elev."

- 3 Input the backsight elevation.

- 4 Measure the backsight.
The instrument takes the backsight reading and displays the measurement.

- 5 Select "Yes" to accept the value.

- 6 Input the elevation that you want to stake out.

- 7 Measure the foresight.
The instrument calculates the difference between the measurement and the input value, and displays the result.

- 8 Move the staff by the amount shown on the screen, then take another foresight reading.

If "Fill" is displayed, move the staff upward.

If "Cut" is displayed, move the staff downward.

When the display shows '0', you have found the specified ground point.

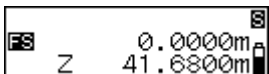

9 Press  or .

Elevation set-out is completed. Set out the next ground point.

Notes:

- When in this menu and setting-out has already been taken (for the second or subsequent reading):

Step 4: The previous backsight measurement will be displayed and the program skips to step 5.

- Storing backsight elevation:

Step 3: Even after power off, backsight elevation is stored. Since this value is the same as the value in the elevation measurement mode, the backsight elevation is stored to whichever mode is set last. (See "10. Measuring Elevation".)

- Storing setting out elevation

Step 6: Even after power off, elevation is stored.

12. Other Measurement Functions

12.1 Measuring Horizontal Angle

You can measure the horizontal angle between point A and point B by using the horizontal circle.

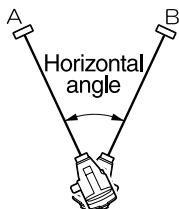

12.2 Using the Instrument as a Standard Level

By using the numeric scale side of the staff, you can use the SDL30/50 as a standard level. Simply focus on the staff and read the scale.

In the Height difference measurement mode and Elevation measurement mode, the sighted value can be manually input in the currently selected JOB. (See "8.4 Flow of Recording Data".)

13. Displaying Recorded Data

Data recorded in Height difference measurement mode or Elevation measurement mode can be edited.

Use the Record Setting Mode to check data and display the number of recorded points.

13.1 Data Check and Edit

Check the contents saved in the currently selected JOB. Attributes can be changed.

Important:

- Attributes can be changed in the following order only: BS (backsight point) → FS (foresight point) → IS (intermediate sight) → FIX (fixed point) → Off → DEL (delete). (Example: Data recorded as IS (intermediate sight) can be changed to FIX (fixed point), Off or DEL (delete), but not to BS (backsight point) or FS (foresight point).
- Point number and measurement results cannot be edited.

Procedure

```
M JOB REC
P1 Ht-diff Elev.
```

```
REC Cond. Line
Review Memory
```

```
Rev. Z 41.7210m
Fs Rh 1.7420m
2001 Hd 35.09 m
```

- 1 In menu mode, select "REC" and then select "Review."



The last recorded data in the currently selected JOB is displayed.

- 2 Display the data that you want to review.

Press  to display the previously displayed data.

Rev.	Z	41.7210m
FS	Rh	1.7420m
2001	Hd	35.09 m

Rev.	Z	41.7210m
FIX	Rh	1.7420m
2001	Hd	35.09 m

- Press .
The attributes can now be changed.
- Display the attribute you want to change.
- Press  to confirm the selected attribute.

Notes:

- "DEL" setting and Number of points that can be recorded

If the DEL attribute is selected for recorded data, the data is not displayed. Setting DEL does not delete data from memory, so the number of points that can be stored in free memory does not increase. When a JOB is deleted, all data with the DEL attributes recorded in other JOBS is also deleted.

- Double-run Measurement



When "Return" is selected, "*" appears in front of measurement value Rh.

13.2 Number of Recorded Points

In the menu mode, select "REC," and then "Memory." The number of points (up to 2000) that can be recorded is displayed.

Free:0123

Note:

- You can reach here also by pressing  and then  in status mode.

14. JOB Delete

Delete the JOB and the contents of the JOB.

Carry out JOB deletion in the JOB setting mode. (JOBS cannot be deleted when the battery is LOW.)

Important:

- JOBS that cannot be output (indicated by * next to JOB) cannot be deleted.

Procedure

```
M  JOB      REC
P1  Ht-diff Elev.
```

```
JOB Select Edit
      Output Delete
```

```
JOB: JOB01
Registered: 0123*
```

```
JOB: JOB01
0123 Yes/No?
```

- 1 In menu mode, select "JOB" and then "Delete."

The currently selected JOB and number of data recorded in the JOB are displayed.

- 2 Display the JOB you want to delete.

- 3 Press , and then select "Yes." The selected JOB and contents of the JOB are deleted.

Notes:

- JOB Quick Access

Step 2: When JOB numbers 1 to 10 are displayed, press **(MENU)** to jump to JOB number 11. When JOB numbers 11 to 20 are displayed, press **(MENU)** to jump back to JOB number 1.

- JOB name

Step 3: After the JOB is deleted, the default JOB name set at the factory is displayed: JOB01 to JOB20.

- Number of points that can be recorded

When a JOB is deleted, data with the DEL attributes recorded in other JOBS is also deleted, and the value indicating the number of points that can be stored in free memory increases.

15. Sending Recorded Data

Recorded data can be sent to a connected computer or data collector. Commands sent from a computer or the data collector instruct the SDL30/50 to carry out measurement, and the measurement results are output.

Important:

- The SDL30/50 accepts commands only when in status mode or menu mode. Received commands are not executed in any other state.

15.1 Connecting to a Computer or Data Collector

Use the dedicated communication cable to connect the SDL30/50 to the data collector or a computer.

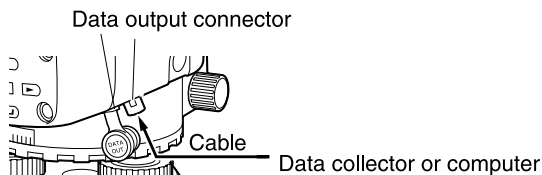

• Communication cable

Computer	Cable	Notes
IBM PC/AT or compatible	DOC26	Length: 2m Pin Numbers and signal levels: RS-232C compatible D-sub connector: DOC26: 25 pins (female) DOC27: 9 pins (female)
	DOC27	
Other personal computers	DOC1	No connector for attachment to a computer.

If using a data collector, use the cable supplied with the data collector.

- **Pin assignments of the data output connector**

Pin No.	Signal
1	SG (GND)
2	NC (unused)
3	SD (TXD)
4	RD (RXD)
5	Power source (output)
6	Reserved (must not be used)

15.2 Data Output

The contents of a JOB can be output to a computer in CSV or SDR2X format.

Important:

- Data recorded in a JOB that has not been sent is indicated by an asterisk (*).

Procedure

- 1 Use a cable to connect the SDL30/50 to a computer. ("15.1 Connecting to a Computer or Data Collector")
- 2 In menu mode, select "JOB" and then "Output." The currently selected JOB and recorded point numbers are displayed.

```
M JOB REC
P1 Ht-diff Elev.
```

```
JOB Select Edit
  Output Delete
```

JOB: JOB01
Registered: 0123*

3 Select the JOB you wish to send.

CSV SDR2x

4 Select the data output format.
Data is output. When data output is completed, the SDL30/50 returns to JOB setting mode.

Note:

- JOB Quick Access

Step 2: When JOB numbers 01 to 10 are displayed, press **(MENU)** to jump to JOB number 11. When numbers 11 to 20 are displayed, press **(MENU)** to jump to JOB number 1.

Step 4: Press **(MENU)** to display the communication conditions setting screen.

- Data output format/command operations

For details, refer to the "Output Format and Command Explanations (SDL Edition)" manual and ask your local dealer.

16. Changing the Settings

You can change settings such as the measuring mode and the number of decimals in displayed data.

When you select "Config." in menu mode, the two-page configuration menu is displayed.

Page 1

- Meas. (measuring mode)
- Display (fractional/decimal representation of height units)
- Adjust (checks and adjustment)
- RS-232C (communication parameters)



Page 2

- Auto-off (auto power-off)
- Unit (unit of measurement)



Notes:

- Press (MENU) to toggle between the pages.
- Asterisks (*) indicate factory settings.
- Settings are kept in memory after power-off.
- "19.2 Adjusting the Reticle" for the check and adjustment procedure.



16.1 Measuring Mode

You can select any of the following measuring modes.



Page 1

- * Single: The instrument automatically terminates fine measurement after taking one reading.
- Average: Displays the average value calculated from the number of times fine measurement is repeated. (Repeat default setting: 5 times, Repeat setting range: 2 to 9 times.)

Waving: For measurement using Wave-and-Read function

Repeat: The instrument repeats fine measurements until the operator presses  or .

Page 2

Tracking: The instrument repeats coarse measurements until the operator presses  or .

Note:

- When  is pressed in Set-out mode, the Measurement conditions setting screen can be displayed.

16.2 Fractional/Decimal Representation of Height Units

You can set the fractional/decimal display format for displaying height values.

The following options are available when using "m" as the unit:

- * 0.0001m: Up to 4 decimals (when measuring mode is "single", "repeat", "average" or "Waving")/Up to 3 decimals (when measuring mode is "tracking")
- 0.001m: Up to 3 decimals ("single", "repeat", "average" or "Waving")/Up to 2 decimals ("tracking").

The following options are available when using "ft" as the unit:

- * 0.001ft: Up to 3 decimals (when measuring mode is "single", "repeat" or "average")/Up to 2 decimals (when measuring mode is "tracking").
- 0.01ft: Up to 2 decimals ("single", "repeat" or "average")/Up to 1 decimal ("tracking").

Only the following option is available when using "inch" as the unit:

- 1/8: **_**_*/*

Note:

The fractional/decimal display format for distance values depends on the settings only in measuring mode.

(See "3.2 Display".)

16.3 Communication Parameters

You can select the communication parameters for connecting a data collector or a computer.

The baud rate and parity settings can be selected from the following.

- Baud rate: *1200 bps / 2400 bps / 4800 bps / 9600 bps / 19200 bps / 38400 bps
- Parity: *None / Odd / Even

Note:

- Outputting start code and end code (CSV format)

Press **MENU** to display the setting screen for outputting start and end codes.

Yes: During data output, outputs start code (STX) and end code (ETX).

* No: Outputs text data only.

16.4 Auto Power-Off

You can enable or disable the auto power-off function.

* On(30min): The instrument powers off automatically 30 minutes after the last key operation.

Off: The auto power-off function is disabled.

16.5 Unit of Measurement

You can select the display unit to be used.

* m

ft

inch

Note:

- If measurement data has already been saved in the selected JOB, the unit of measurement cannot be changed.
- "Inch" here means "fraction of an inch", "fraction of an inch" is the unit used in the United States and expressed like the following example.

10.875 feet → 10-10-1/2 inch

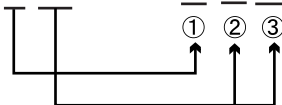

- ① 10.000 feet
- ② 0.875 feet x 12=10.5 inch
- ③ 0.5 inch=1/2 inch

17. Warnings and Error Messages

The table below shows the warnings and error messages displayed by the SDL30/50 and describes the cause of each warning or error message.

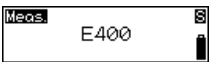
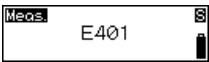
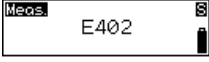
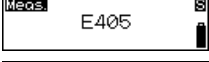
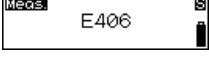
Error Message	Coded Message	Meaning
	E400	<ul style="list-style-type: none">• System error due to a fault in the instrument. Contact your local dealer.• Calculation error in Wave-and-Read measurement.
	E401	
	E402	
	E405	
	E406	

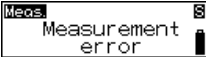
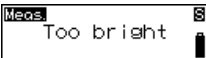
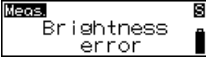
Error Message	Coded Message	Meaning
	E410 E411 E412 E413 E414 E415 E416 E417 E418 E419 E420 E421 E422 E423 E424 E425 E426 E427 E428 E429	<ul style="list-style-type: none"> • An object other than the staff is being sighted. • The staff is out of focus. • The staff is partly unreadable because obscured by an obstacle or damaged. • The staff is too close or too far away. • A shadow is falling on part of the staff. • The staff was incorrectly sighted. • Light is coming into the eyepiece. Use your hand or body to shield eyepiece from light source. • The staff is set up in the inverted position for Wave-and-Read measurement.
	E430 E433	<ul style="list-style-type: none"> • Too bright. • The brightness level suddenly altered during the measurement. • Something is shining nearby or at back of the staff. • Light is coming into the eyepiece. • Use your hand or body to shield eyepiece from light source.
	E431	<ul style="list-style-type: none"> • Something obscured the staff or the brightness level suddenly altered during the measurement.

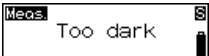
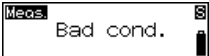
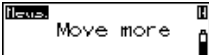
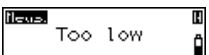
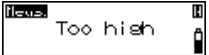
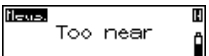
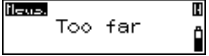
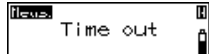
Error Message	Coded Message	Meaning
	E432	<ul style="list-style-type: none"> • Too dark. • The brightness level suddenly altered during the measurement.
	E440	<ul style="list-style-type: none"> • The instrument is subject to excessive vibrations or hot conditions are producing shimmer.
		<ul style="list-style-type: none"> • The staff is stationary, or the waving angle thereof is insufficient when performing Wave-and-Read measurement.
 	E456 E457	<ul style="list-style-type: none"> • The staff height being sighted is either less than 0.5m (too low) or greater than 4m (too high) when performing Wave-and-Read measurement.
 	E458 E459	<ul style="list-style-type: none"> • The distance to the staff is either less than 5m (too near) or greater than 50m (too far) when performing Wave-and-Read measurement.
	E498	<ul style="list-style-type: none"> • Measurement results not obtained within 20 seconds of starting Wave-and-Read measurement.

Note:

Coded messages are not displayed on SDL30/50 display.

18. Charging the Battery

Important:

- Do not short circuit. Heat or ignition could result.
- Batteries cannot be charged, even when the charging lamp is flashing, when the temperature is outside the charging temperature range.
- Do not leave the battery anywhere exposed to high temperatures. Battery life may be reduced.
- Charge the battery once a month to maintain its quality when not in use for long periods.
- Do not charge the battery just after charging is completed. Battery performance may decline.
- Do not use to charge batteries other than those specified.
- If you allow the battery level to get too low, the battery may not be rechargeable or operating time may decline. Keep the battery always charged.
- The charger will get rather hot while in use. This is normal.

Procedure

- 1 Connect the power cable to the CDC68 charger and plug the charger into the wall outlet.
- 2 Mount the battery (BDC46B) in the charger (CDC68) matching the groove on the battery with the guides on the charger.
When charging starts, the lamp starts blinking.

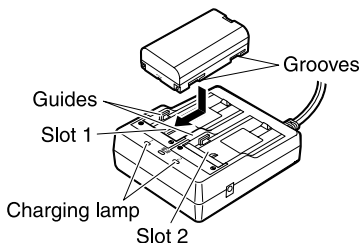

- 3 Charging takes approximately 2.5 hours.
The lamp lights when charging is finished.
- 4 Remove the battery and unplug the charger.

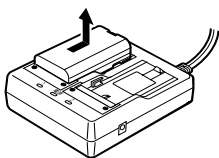

Notes:

- **Slots 1 and 2**

- Step 2: The charger starts charging the battery mounted first. If you place two batteries in the charger, the battery in slot 1 is charged first, and then the battery in slot 2.

- **Charging lamp**

- Steps 2 and 3: The charging lamp is off when
 - The charger is outside the charging temperature range.
 - The battery is mounted incorrectly.If the lamp is still off after the charger falls within its charging temperature range and the battery is mounted again, contact your local dealer.

19. Checks and Adjustments

Always check and adjust before use to ensure accurate measurements.

- Make sure the instrument is securely set up and stable before performing checks and adjustments.
- Do not perform checks and adjustments with “Waving” selected as measuring mode.

19.1 Adjusting the Circular Level

Check that the bubble remains centered in the circular level. Adjust if the bubble shifts position.

Procedure

- 1 Adjust the leveling foot screws until the bubble is centered in the circle.
- 2 Turn the instrument 180° .
The bubble should not shift from the center. If the bubble does move, adjust as follows:
- 3 Compensate for one-half of the shift by adjusting the leveling foot screws

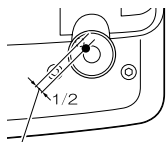

Adjust with the leveling foot screw

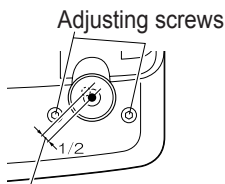

Adjust with the level adjusting screw

- 4 Eliminate the remaining shift by turning the circular level adjusting screws with the hexagonal wrench until the bubble is centered.
- 5 Turn the instrument 180°. If the bubble stays in the center, adjustment is completed. If the bubble moves, repeat steps 3 and 4.

19.2 Adjusting the Reticle

The reticle cross-lines can be corrected if out of adjustment. While reading the staff RAB-code, adjust the reticle by correcting the reference value of the CCD line sensor and then make mechanical adjustments to the instrument.

- **Correcting the reference value of the CCD line sensor**

As described in the following procedure, high accuracy readings are obtained by turning the tripod and taking repeat readings of the staff. For less accurate readings, see Notes for checking the reticle without turning the tripod.

Procedure

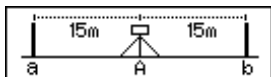

- 1 In menu mode, select "Config", then in page 1 of the Config. menu, select "Adjust".
- 2 Place staffs a and b approximately 30m apart and set the instrument halfway between the staffs (position A).

Place staffs to within 50cm (20 inch) of the distances described in the procedure.

Otherwise, measurement accuracy may be adversely affected.

- 3 Press .
- 4 Measure staff a.
- 5 Select "Yes" to accept the value.

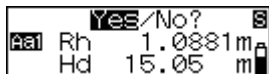

- 6 Measure staff b.
- 7 Select "Yes" to accept the value.

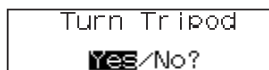
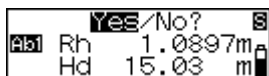

- 8 Select "Yes".
- 9 Turn the tripod 180°.
- 10 Repeat steps 4 through 6, sighting the two staffs and taking the readings.
- 11 Select "Yes" to accept the value.

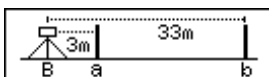
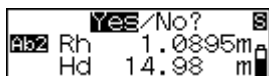

- 12 Move the instrument to a position approximately 3m from staff a along a straight line joining staffs a and b. The new position is B.

- 13 Press .

- 14 Repeat steps 4 through 11, sighting the two staffs and taking the readings. If you turned the tripod at step 8, a diagram of the tripod positions will be displayed. Turn the tripod again.

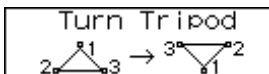

diff. 0.0017m
Adjust Yes/No?

- 15 Check the difference between the results and decide whether correcting the reference value of the sensor is required.

If the difference is 0.3mm or less, no adjustment is necessary.

If the difference exceeds the 0.3mm permissible range, adjustment is necessary.

If correcting the reference value is not necessary:

diff. 0.0017m
Adjust Yes/**No**?

16 Select "No".

Exit Adjust
Yes/No?

17 Select "Yes" to exit from the Adjust menu.

If correcting the reference value is required:

diff. 0.0045m
Adjust **Yes**/No?

16 Select "Yes".

The instrument calculates and records the required reticle adjustment from the measurement results, and then returns to the menu selection.

17 Repeat steps 1 through 15. Make sure that the difference between the results is within 0.3mm.

• Mechanical adjustment



1 Sight the barcode face of staff b from position B and measure with the instrument.



2 Sight the scale face of staff b from position B and take a visual reading.

3 If the difference between the measurements taken at steps 1 and 2 is 2mm or more, adjust the cross-line as described below.

If the difference is less than 2mm, the following steps are not necessary.

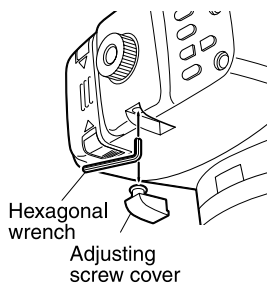

- 4 Remove the adjusting screw cover and insert a hexagonal wrench (M3) in the adjusting screw.
- 5 Turn the adjusting screw, then repeat steps 1 and 2. Adjust so that the difference between the two measurements is less than 2mm.

If the measurement at step 2 is larger than the measurement at step 1, lower the cross-line by slightly loosening the adjusting screw.

If the measurement at step 2 is smaller than the measurement at step 1, raise the cross-line by slightly tightening the adjusting screw.

- 6 Replace the adjusting screw cover.

Notes:

- **Saving measurement values during correcting the reference value of the sensor and power off**

- Steps 9, 12 and 14:

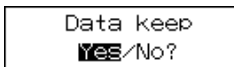

"Data keep" screen asks whether or not you want to save the measurement values during setting internal constants.

Select "Yes" to save measurement values and turn power off. When power is turned on again and page 1 of the Config. menu is selected, Screen Status at last power off is displayed.

Select "No" to cancel measurement values and turn power off.

- **Difference calculations:**

- Step 15: If the tripod is turned and repeat measurements taken:

Value at position A = $\{[(1\text{st reading on staff a}) + (1\text{st reading on staff b})] + [(2\text{nd reading on staff a}) - (2\text{nd reading on staff b})]\} / 2$

Value at position B = $\{[(1\text{st reading on staff a}) + (1\text{st reading on staff b})] + [(2\text{nd reading on staff a}) - (2\text{nd reading on staff b})]\} / 2$

Difference = absolute value of $[(\text{value at position A}) - (\text{value at position B})]$

If the tripod is not turned and only one set of measurements are taken:

Value at position A = $[(\text{reading on staff a}) - (\text{reading on staff b})]$

Value at position B = $[(\text{reading on staff a}) - (\text{reading on staff b})]$

Difference = absolute value of $[(\text{value at position A}) - (\text{value at position B})]$

20. Equipment and Accessories

20.1 Standard Equipment

Before using your SDL30/50, first make sure that all the following products were supplied.

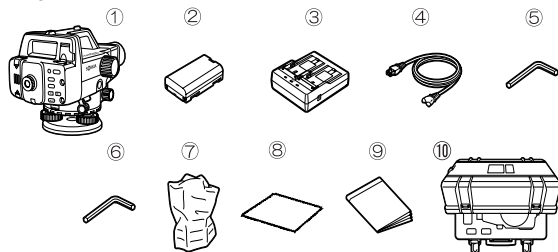

• Layout Plan

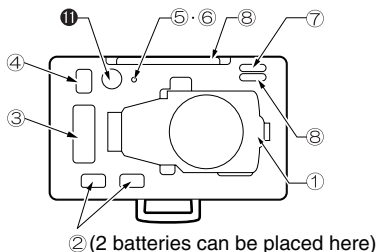

①	SDL30/50	1
②	Battery (BDC46B)	1
③	Charger (CDC68)	1
④	Power cable (EDC113A/113B/113C)	1
⑤	Hexagonal wrench M2.5 (for circular level)	1
⑥	Hexagonal wrench M3 (for reticle adjustments)	1
⑦	Dust cover	1
⑧	Cleaning cloth	1
⑨	Operator's manual	1
⑩	Carrying case	1
	The optional accessory can also be placed in the carrying case.	
⑪	Diagonal eyepiece (DE23)	1

20.2 Optional Accessory

- **Diagonal eyepiece (DE23)**

The diagonal eyepiece is useful for taking measurements in confined spaces.

First remove the standard SDL30/50 eyepiece by turning it counter-clockwise. Then, screw the diagonal eyepiece in place of the standard eyepiece.

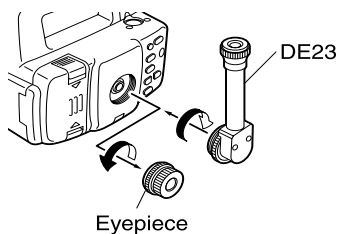

20.3 Staffs

- Staff types

Name	Material	Length/Front/Reverse	Feature
BIS20	Invar	2.0m (6.6ft) Front: RAB code	ISO 12858-1: 1999 compatible
BIS30	Invar	3.038m (9.8ft) Front: RAB code	ISO 12858-1: 1999 compatible For high precision leveling
BGS40	Glass fiber	4.08m (3 sections) Front: RAB code Reverse: graduated	With handle
BGS50	Glass fiber	5.09m (4 sections) Front : RAB code Reverse: graduated	With handle
BGS50G	Glass fiber	5.09m (4 sections) Front : RAB code Reverse: graduated	With handle Unit: feet
BAS55	Aluminum	5.0m (5 sections) Front: RAB code Reverse: graduated	
BRS55	Aluminum	5.0m (5 sections) Front: RAB code Reverse: graduated on reflective surface	Distances can be measured with Total Station by using the reverse side (reflective sheet). (Applies only to instruments that can measure in sheet mode.)

*:RAB code (RAndom Bi-directional code) is a coded staff used with SOKKIA digital levels.

21. Specifications

Except where stated, the following specifications apply to all SDLs.

Telescope

Length	260 mm
Objective aperture:	SDL30: Ø45mm SDL50: Ø36mm
Magnification:	SDL30: 32x SDL50: 28x
Image:	Erect
Resolving power:	SDL30: 3" SDL50: 3.5"
Field of view:	1°20'
Minimum focus:	1.5m (5.0 ft)
Stadia ratio:	1:100
Stadia additive constant:	0

Staffs

Invar staff

BIS20:	85mm (W) x 40mm (D) x 2000mm (H) {3.4in. (W) x 1.6in. (D) x 6.6ft (H)} 4.3kg (9.5lb.) (one staff) 17.1kg (37.7lb.) (two staffs and case)
BIS30:	85mm (W) x 40mm (D) x 3038mm (H) {3.4in. (W) x 1.6in. (D) x 10.0ft (H)} 5.5kg (12.2lb.) (a staff) 23.4kg (51.6lb.) (two staffs and case)

The coefficient of linear expansion: $\alpha=1 \times 10^{-6} / ^\circ\text{C}$

Glass fiber staff

BGS40:	58mm (W) x 28mm (D) x 4080mm (H) (3 sections) {2.3in. (W) x 1.1in. (D) x 13.3ft (H)} 2.4kg (5.3lb.) (one staff) 3.0kg (6.6lb.) (a staff and case)
BGS50/50G:	58mm (W) x 28mm (D) x 5090mm (H) (4 sections) {2.3in. (W) x 1.1in. (D) x 16.7ft (H)} 3.0kg (6.6lb.) (one staff) 3.6kg (8.0lb.) (one staff and case)

The coefficient of linear expansion: $\alpha=20 \times 10^{-6} / ^\circ\text{C}$

Aluminum staff
 BAS55: 50mm (W) x 27.8mm (D) x 5005mm (H)
 (5 sections)
 {2.0in. (W) x 1.1in. (D) x 16.4ft (H)}
 1.9kg (4.2lb.) (one staff) 2.2kg (4.9lb.)
 (one staff and case)

The coefficient of linear expansion : $\alpha=24 \times 10^{-6} / ^\circ\text{C}$

Measurement

Horizontal circle:	Diameter: 103mm Graduation: 1° / 1gon
Measuring range:*1	
Height	0 to 4m (13.3 ft) (with BGS40 staff) 0 to 5m (16.7 ft) (with BGS50 staff) SDL30: 0.0375 to 1.9305m (0.124 to 6.333 ft) (with BIS20 staff) 0.0375 to 2.9725m (0.124 to 9.752 ft) (with BIS30 staff)
Distance	1.6 to 100m
Minimum display:	
Height	0.0001m / 0.001m (0.001 ft/0.01ft) (selectable) (single, repeat, average or Wave-and-Read mode) 0.001m / 0.01m (0.01ft/0.1ft) (tracking mode)
Distance	0.01m (0.1ft) (single, repeat or average mode) 0.1m (1 ft) (tracking or Wave-and-Read mode)
Accuracy:*1	(with SOKKIA staff BGS40/50 or BIS20/30)
Height	Standard deviation for 1 km of double-run
SDL30:	
Electronic Measurement	0.6mm (0.03in.) (with BIS20/30) 1.0mm (0.04in.) (with BGS40/50/50G) 1.2mm (0.047in.) (with BAS55)
Visual Measurement	1.0mm (0.04in.) (with BGS40/50/50G) 1.5mm (0.06in.) (with BAS55)

SDL50:

Electronic Measurement

- 0.8mm (0.03in.) (with BIS20/30)
- 1.5mm (0.06in.) (with BGS40/50/50G)
- 1.7mm (0.047in.) (with BAS55)

Visual Measurement

- 2.0mm (0.08in.) (with BGS40/50/50G)
- 2.5mm (0.06in.) (with BAS55)
- Distance $\pm 10\text{mm}$ (less than 10m measurement)
- $\pm(0.1\% \times D)$ (10 to 50m measurement)
- $\pm(0.2\% \times D)$ (more than 50m measurement)
- (D: measured distance, unit: m)
- Measuring modes: Single / Repeat / Average / Tracking / Wave-and-Read (selectable)
- Measuring time:*2
- Single / Repeat approx. 2.5 sec.
- Average No. of measurements set x approx. 2.5 sec.
- Tracking approx. 1 sec.
- Automatic compensator: Magnetic damping and pendulum mechanism
- Compensation range: $\pm 15'$

Wave-and-Read

Recommended brightness level for measurement

150 lx or more

Recommended speed for waving of staff

0.5Hz (3 passings of the staff through the vertical position in 3 seconds)

Measuring range

Waving angle: 5 to 10° either side of the vertical position

Height: 0.5 to 4m

Distance: 5 to 50m

Recommended staff*3: BGS series

BAS55 (up to heights of 3m)

- *1 When measuring outdoors with minimal atmospheric motion, the staff set up in natural sunlight and luminosity at the surface of the staff equal to 20lx.
- *2 When measuring to a staff set up outdoors in fine to cloudy conditions.
- *1, 2 These specifications may change depending on the weather conditions and measurement conditions.

- *3 Staff face remains sighted in the reticle throughout the entire waving movement.

Power

Power supply:	Rechargeable Li-ion battery (BDC46B)
Battery state indicator:	4 levels
Working duration:	more than 16 hours (at 25°C)
Charging time: (BDC46B)	about 2.5 hours*4 (using CDC68)
Nominal voltage:	7.2V
Storage temperature range: (CDC68)	-20 to 35°C (-4 to 95°F)
Input voltage:	with EDC113A/113C:110 to 240VAC 50/60Hz with EDC113B:110 to 125VAC 50/60Hz
Charging temperature range:	0 to 40°C (32 to 104°F)
Storage temperature range:	-20 to 65°C (-4 to 149°F)

- *4 Charging can take longer than the times stated above when temperatures are either especially high or low.

General

Display:	128 x 32 dot matrix LCD with illuminator
Keypad:	8 keys (7 keys on front panel; 1 key on side panel)
Auto power-off:	On (instrument powers off if not used for 30 min.) / Off (selectable)
Data output:	RS-232C compatible
Circular level sensitivity:	10'/2mm
Operating temperature range:	-20 to 50°C (-4 to 122°F)
Storage temperature range:	-40 to 70°C (-40 to 158°F)
Water resistance:	IPX4
Dimensions:	158 (W) x 257 (D) x 182 (H) mm (6.2 (W) x 10.1 (D) x 7.2 (H) inch)
Weight (with battery):	about 2.4kg (5.3lb)

22. Regulations

For users in the US

WARNING: Changes or modifications to this unit not expressly approved by the party responsible for compliance could void the user's authority to operate the equipment.

NOTE: This equipment has been tested and found to comply with the limits for a Class A digital device pursuant to Part 15 of the FCC Rules. These limits are designed to provide reasonable protection against harmful interference when the equipment is operated in a commercial environment. This equipment generates, uses, and can radiate radio frequency energy and, if not installed and used in accordance with the instruction manual, may cause harmful interference to radio communications. Operation of this equipment in a residential area is likely to cause harmful interference in which case the user will be required to correct the interference at his own expense.

For users in California

WARNING: Handling the cord on this product or cords associated with accessories sold with this product will expose you to lead, a chemical known to the State of California to cause birth defects or other reproductive harm.
Wash hands after handling.

For users in Canada

This Class A digital apparatus meets all requirements of Canadian Interference-Causing Equipment Regulations. Cet appareil numérique de la Class A respecte toutes les exigences du Règlement sur le matériel brouilleur du Canada.

For users in the Republic of Korea

A 급 기기 (업무용 정보통신기기)

이 기기는 업무용으로 전자파적합등록을 한 기기이오니 판매자 또는 사용자는 이 점을 주의하시기 바라며 만약 잘못 판매 또는 구입하였을 때에는 가정용으로 교환하시기 바랍니다.



Li-ion

CONTAINS Li-ion BATTERY.
MUST BE RECYCLED OR DISPOSED OF PROPERLY.

JSIMA

This is the mark of the Japan Surveying
Instruments Manufacturers Association.

SOKKIA TOPCON CO., LTD.

<http://www.sokkia.co.jp/english/>

260-63 HASE, ATSUGI, KANAGAWA, 243-0036 JAPAN

13th ed. 16-1003

©2000 SOKKIA TOPCON CO., LTD.