

SOKKIA

SET3^{110R}
SET4^{110R}

Non Prism Electronic Total Station

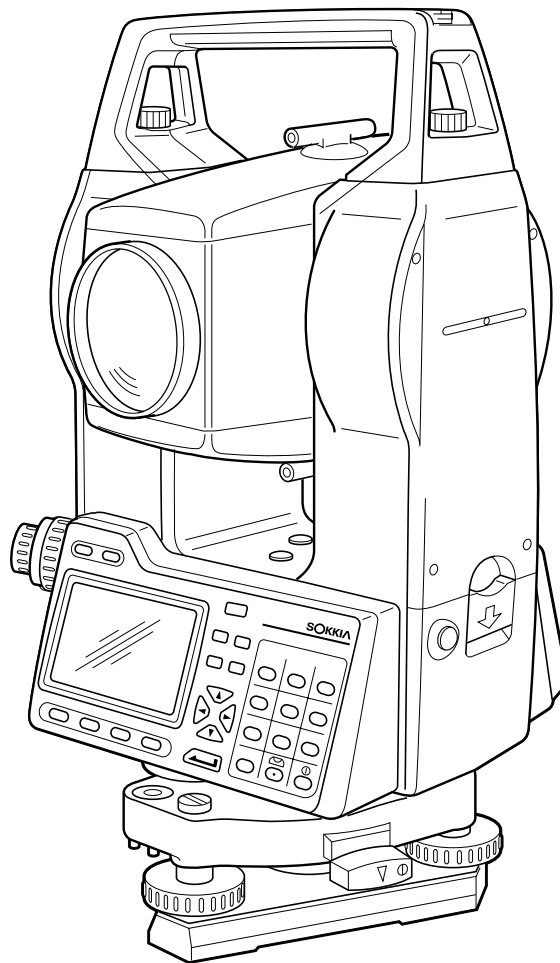

Class 1 Laser Product

OPERATOR'S MANUAL

SET3110R/4110R are electronic total stations with a non prism measurement function that enables you to measure to your desired target surface.

The functions and operation of the SET3110R/4110R and SET2110/3110/4110 are almost the same.

This operator's manual explains only the functions that are unique to SET3110R/4110R.

See the "SET2110/3110/4110 Operator's Manual" for an explanation of precautions and other operations.

- Thank you for selecting the Non Prism Electronic Total Station SET3110R/4110R.
- Before using the instrument, please read this manual and the "SET2110/3110/4110 Operator's Manual."
- Verify that all equipment is included by referring to "STANDARD EQUIPMENT" in the "SET2110/3110/4110 Operator's Manual."
- The specifications and general appearance of the instrument may be altered at any time and may differ from those appearing in brochures and this manual.
- Some of the diagrams shown in this manual may be simplified for easier understanding.



This is the mark of the Japan Surveying Instruments Manufacturers Association.

SOKKIA Customer Service

SOKKIA CO.,LTD.

<http://www.sokkia.co.jp/english/>

INTERNATIONAL DEPT.

20-28, ASAHICHO 3-CHOME, MACHIDA, TOKYO, 194-0023 JAPAN
PHONE +81-42-729-1848 FAX +81-42-729-1930

SOKKIA CO.,LTD.

<http://www.sokkia.co.jp/english/>

1-1, TOMIGAYA 1-CHOME, SHIBUYAKU, TOKYO, 151-8511 JAPAN
PHONE +81-3-3465-5211 FAX +81-3-3465-5203

FC21831-A02

8th ed. 08-0102

©1999 SOKKIA CO., LTD

1.

LASER SAFETY INFORMATION

The SET3110R/4110R is classified as a class 1 Laser Product according to the United States Government Code of Federal Regulation CFR21.

CAUTION

- Use of controls or adjustments or performance of procedures other than those specified herein may result in hazardous radiation exposure.
- The labels shown below are attached to the SET according to the United States Government Code of Federal Regulation CFR21. Follow the instructions on the labels to ensure safe use of the laser product.

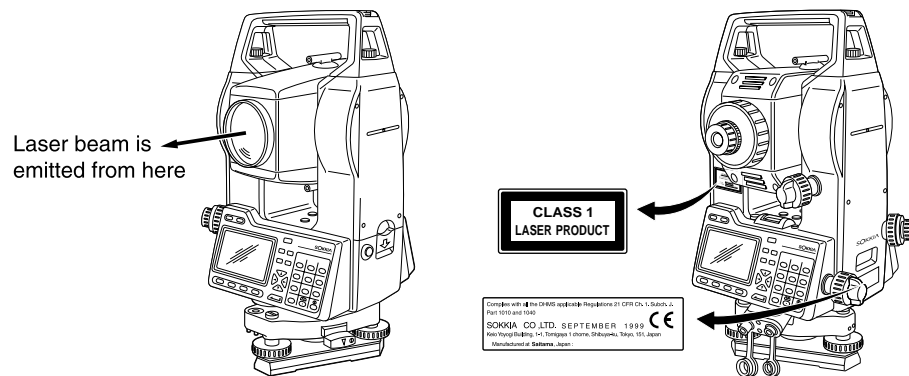

When the laser beam is emitted, "!" is displayed in the bottom corner of the screen.

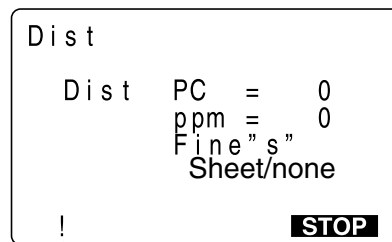

Laser beam is emitted

2. DISTANCE MEASUREMENT

- Keep in mind the following points when using the reflective sheet for measurement. When sighting the reflective sheet with the telescope, sunlight may be reflected from the sheet causing glare. If measurement is carried out, measurement results may be incorrect. Adjust the angle of the reflective sheet so that it does not reflect sunlight.
- As the Non Prism Electronic Total Station emits a narrow, collimated laser beam that is almost parallel (little diffraction), Sokkia recommends the use of a single AP prism for accurate measurement results. We do not recommend the use of multi-element prisms.

- This section explains distance measurement. First complete the preparations in 2.1 and 2.2 in order to perform distance measurements.

2.1 Settings for Distance Measurements

- Perform the following four settings as preparation for distance measurements.
 - Atmospheric correction factor
 - Target type
 - Prism constant correction value
 - Distance measurement mode

PROCEDURE Settings for distance measurements

```
EDM
Reflector: Sheet / none
PC       : 0
Mode     : Fine"s"
↓
OPPM
```

```
Temp      : 15°C
Press     : 1013 hPa
Humid     : 0%
ppm       : 0
```





1. Press [EDM] in Page 1 of MEAS Mode.

The "EDM Setting Screen" is displayed.

2. Set the following items

- (1) Target type
- (2) Prism constant correction value
- (3) Distance measurement method
- (4) Temperature
- (5) Air pressure
- (6) Humidity
- (7) Atmospheric correction factor

After setting these, press .

- Setting method and content
 - (1) Reflector: Select it with  or . (selection: prism, sheet/none)
 - (2) PC: Enter the prism constant correction value suited to the target used.
 - (3) Mode: Select it with  or .
(Selection: Fine "S", Rapid "S")
 - (4) to (7): Temp., Press., Humid., ppm

It is possible to set the atmospheric correction factor in the following two ways.

 1. Entering the air temperature, pressure, and humidity (Temp., Press., Humid)
After they are entered, the atmospheric correction factor is automatically calculated, and [ppm] in (4) is displayed. When parameter "Atmospheric Correction" is set to "temperature and air pressure," item (3) Humidity cannot be displayed.
 2. Directly entering the atmospheric correction factor (ppm).
After the entry, the values for [Temp], [Press.] and [Humid.] are erased.
- Setting the atmospheric correction factor to 0 ppm. [0ppm]

3. After all setting is completed, press  on the Mode line.

"MEAS Mode Screen" is restored.

EXPLANATION **Atmospheric correction**

- The atmospheric correction is necessary for accurate distance measurement because the velocity of light in air is affected by the temperature and air pressure.

NOTE: To obtain the average refractive index of the air throughout the measured light path, you should use the average atmospheric pressure and temperature. Take care when calculating the correction factor in mountainous terrain. See "27. Atmospheric Correction for High Precision Distance Measurements" in the "SET2110/3110/4110 Operator's Manual."

- The SET is designed so that the correction factor is 0 ppm at an air pressure of 1,013 hPa and a temperature of 15°C.
- By inputting the temperature and air pressure values, the correction value is calculated and set into the memory.

Calculate the atmospheric correction factor as shown in the following formula.

$$\text{ppm} = 278.96 - \frac{0.2904 \times \text{air pressure (hPa)}}{1 + 0.003661 \times \text{air temperature (°C)}}$$

If the atmospheric correction is not required, set the ppm value to 0.

- It is also possible to enter the atmospheric correction factor by directly entering the ppm value. To input the ppm value, read the correction factor from the "Atmospheric Correction Chart" at the end of the "SET2110/3110/4110 Operator's Manual."

- For more precise measurements, account for atmospheric corrections related to humidity.
See "27 Atmospheric Correction for High Precision Distance Measurements" in the "SET2110/3110/4110 Operator's Manual."
When a SET is shipped from the factory, it is set so that only the corrections to temperature and to air pressure are performed. When you wish to set humidity, first change the atmospheric correction factor setting of parameter No. 1 to [+humidity], then set the atmospheric correction factor. For details, see "9.5 Setting the Instrument Options" in the "SET2110/3110/4110 Operator's Manual."

EXAMPLE

Finding the atmospheric correction factor from the atmospheric correction chart when the temperature = +25°C and the air pressure = 1,000hPa.

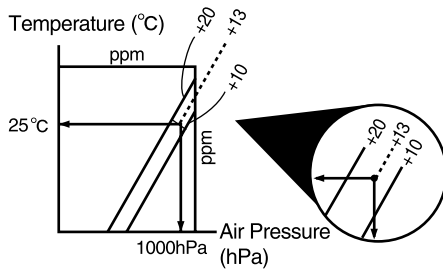

- The atmospheric correction factor from the table on the left is 13 ppm.

2.2 Returned Signal Checking

- Check to make sure that sufficient reflected light is returned by the target sighted by the telescope. Checking the returned signal is particularly useful when performing long distance measurements.
- The instrument can be switched to returned signal checking at any time except the following times:
During distance measurement, resection calculation or circular level display

PROCEDURE Returned signal checking

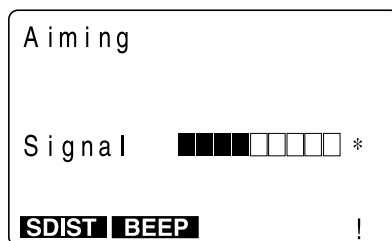

1. Accurately sight the reflecting target, and press **SFT** and **+/-** in any screen.

The "Returned Signal Check Screen" is displayed.

The intensity of the light of the returned signal is displayed by a gauge.

- : No light
- : Too much light
- : Distance measurement possible
- : Distance measurement possible

- The more [■] displayed, the greater the quantity of reflected light.
- If [*] is displayed, only enough light for the measurement is returned.
- Press [BEEP] to make a buzzer sound at the same time that [*] appears when distance measurement is possible. Press [OFF] to shut off the buzzer.

2. Press **ESC** to end the check and return to the original screen.
If no key operations are performed for 10 seconds, the display automatically returns to the original screen.

Press [SDIST] to start distance measurement.

- When [*] is not displayed, either resight the target, or in the case of long distance measurement with the reflective prism, increase the number of prisms.
- When □□□□□□□■□□ is displayed persistently, contact your SOKKIA agent.

NOTE: When the light intensity is sufficient even though the target and the reticle are slightly misaligned (short distance etc.), [*] will be displayed in some cases, but in fact, accurate measurement is impossible. Therefore make sure that the target center is sighted correctly.

2.3 Distance and Angle Measurement

- An angle can be measured at the same time as the distance.
- When recording measurement data, see "19.1 Recording Distance Measurement Data" in the "SET2110/3110/4110 Operator's Manual."

CHECK

Check the following once more before measuring a distance

1. The SET is set up correctly over the surveying point.
2. The battery is sufficiently charged.
3. The horizontal circle and vertical circle indexing have been completed.
4. The parameters are set in conformity with measurement conditions.
5. The atmospheric correction factor has been set, the target type has been selected, the prism constant correction value has been set, and the distance measurement method has been selected.
6. The center of the target is correctly sighted and the light intensity of the returned signal is sufficiently high.

PROCEDURE

S/H/V selection and distance measurement

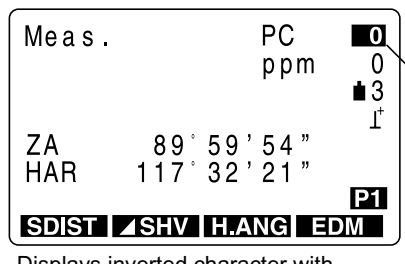

Displays inverted character with black background when Sheet/none is selected

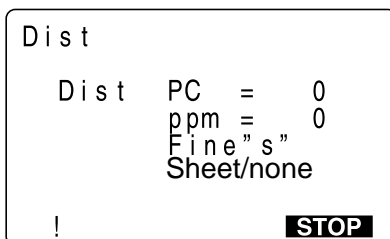

1. In the first page of MEAS Mode, press [SHV] to select the desired distance mode.

Each time [SHV] is pressed, the distance measurement mode changes.

[SDIST] : Slope distance
 [HDIST] : Horizontal distance
 [VDIST] : Height difference

2. Press [SDIST]

When measurement starts, EDM information (prism constant correction value, atmospheric correction factor, distance measurement method, reflector type (only when "Sheet/none" is selected)) is represented by a flashing display.

When distance measurement is completed, a short beep sounds, and the measured distance data (S), vertical angle (ZA), and horizontal angle (HAR) are displayed.

-
- When the distance cannot be measured because it is shorter than the measuring range or because it is longer than the measuring range during measurement with the reflective sheet, the screen displays " - - - - ."
 - The distance and angle which are most recently measured remain stored in the memory until the power is turned off. It is possible to display the measured values converted into the horizontal distance, height difference, and the slope distance by pressing [▲SHV]. And because the distance measurement value, vertical angle, horizontal angle, and the XYZ coordinates can be displayed, it is possible to display the distance measurement values converted into the horizontal distance, elevation difference, and the slope distance.
For the display method, see "2.4 Review of Measured Data."

2.4 Review of Measured Data

- The distance and angle measured most recently are stored in the memory until the power is switched off.

And because the distance measurement value, vertical angle, horizontal angle, and the XYZ coordinates can be displayed, it is possible to display the distance measurement values converted into the horizontal distance, elevation difference, and the slope distance.

- In advance, allocate the function key to display [RCL]. For the allocation method, see "23. Key Function Allocation" in the "SET2110/3110/4110 Operator's Manual."

PROCEDURE Data recall

```
RCL
S      1 234.567m
ZA     30° 58' 59"
HAR    126° 31' 17"
N      -1234567.789
E       34567.123
Z      1234567.123
┌─SHV
```

1. In MEAS Mode, display the screen in which [RCL] is registered, and press [RCL].

The stored data which is most recently measured is displayed.

2. To alternately display the horizontal distance, height difference, and the slope distance, press [└SHV].

Each time [└SHV] is pressed, S, H, and V are displayed alternately.

S : Slope distance
H : Horizontal distance
V : Height difference

3. Press **ESC** to return to MEAS Mode.

2.5 Measuring Distance and Outputting the Data to a Computer

- Distance measurement can be performed and the data is quickly output to a computer.
- In advance, allocate the function key to display [D-OUT]. For the allocation method, see "23. Key Function Allocation" in the "SET2110/3110/4110 Operator's Manual."

PROCEDURE Measuring distance and outputting the data to a computer

```
Meas.      PC      0
           ppm     0
           ▣3
           f
ZA      89 59' 54"
HAR    117 32' 21"
           P1
SDIST  SHV  D-OUT  EDM
```

1. In MEAS Mode, display the screen in which [D-OUT] is registered.

```
D-OUT
1. Dist data
2. Angle data
```

2. Press [D-OUT]. "Measurement Selection Screen" is displayed.
3. Select "1. Dist data," and press . When measurement starts, EDM information (distance mode, prism constant correction value, atmospheric correction factor, distance measurement method) is represented by a flashing display.

When distance measurement is completed, a short beep sounds, and the measured distance data (S), vertical angle (2A), and horizontal angle (HAR) are displayed.

Then the measured data begins being output.

When repeat measurement is performed, press [STOP] to stop the output.

When "2. Angle data" is selected in step 2, the angle data which is displayed on the screen can be output. (Be sure that angle measurement cannot be performed.) Turn the instrument until the required angle is displayed and select "2. Angle data" to output the data.

3. RECORDING IN RECORD MODE

- Items on this page differ slightly from those found in “19.4 Recording Instrument Station Data” of the SET2110/SET3110/SET4110 Operator’s manual.
- The items which can be recorded are the instrument station coordinates, point number, codes, instrument height, operator, date, time, weather, wind, target type, prism constant correction value, distance measurement method, temperature, air pressure, humidity, and atmospheric correction factor.

PROCEDURE Recording instrument station data

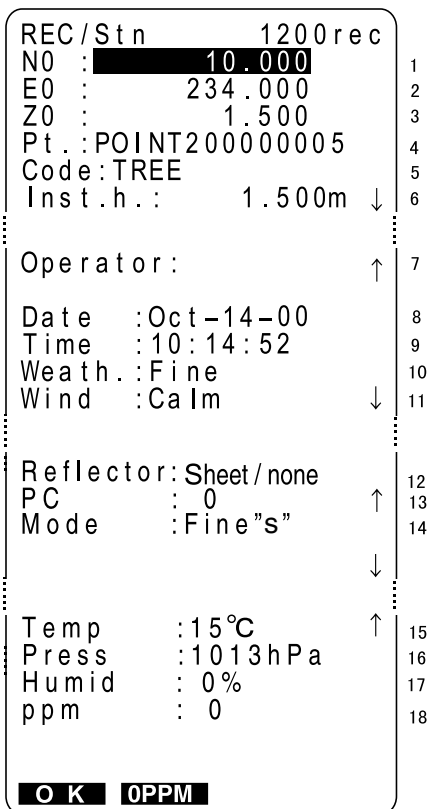

1. Press **[REC]** in the second page of MEAS Mode.
The “Record Mode Screen” is displayed.
2. Select “4.Stn data” and press 
The Instrument Station Data Setting Screen” is displayed.
There are a total of 4 pages.
3. Set the following data items.

1 to 3	Instrument station coordinates
4	Point number
5	Code
6	Instrument height
7	Operator
8	Date
9	Time
10	Weather
11	Wind
12	Target type
13	Prism constant correction value
14	Distance measurement method
15	Temperature
16	Air pressure
17	Humidity
18	Atmospheric correction factor



- Setting method and content

12 Reflector: Select it with  or . (selection: prism, sheet/none)

14 Mode: Select it with  or .
(Selection: Fine "S", Rapid "S")

4. When the setting is completed, press [OK].
Instrument station data is recorded and the
"Record Mode Screen" is restored.

4. SPECIFICATIONS

Telescope

Length:	165 mm
Aperture:	45 mm (EDM: 50 mm)
Magnification:	30x
Image:	Erect
Resolving power:	3"
Field of view:	1°30"
Minimum focus:	1.0 m
Focussing screw:	Fine/Coarse 2-speed
Reticle illumination:	Bright / dim (selectable)

Angle measurement

Horizontal and Vertical circles type:	Increment with 0 index (Both circles adopt diametrical detection)
Angle units:	Degree/Gon/Mil (Selectable with parameter)
Minimum display:	1" (0.2 mgon/0.005mil)/5" (1 mgon/0.02 mil) (Selectable with parameter)
Accuracy:	SET3110R: 3" (1.0 mgon) SET4110R: 5" (1.5 mgon) Standard deviation (ISO 12857-2(1997))
Measuring time:	Less than 0.5 sec
Automatic compensator:	Selectable ON (V & H/V)/OFF Type: Liquid 2-axis tilt sensor Range of compensation: $\pm 3'$
Measuring mode:	Horizontal angle: Right/Left selectable Vertical angle: Zenith 0°, horizontal 0°, horizontal 0 \pm 90°

Distance Measurement

Measuring method:	Coaxial phase-contrast measuring system
Measuring range:	(Slight haze, visibility about 20 km, sunny periods, weak scintillation / values in parentheses () : no haze, visibility about 40 km, cloudy periods, no scintillation) White surface * : 2 to 85 m Reflective sheet RS90N : 2 to 500 m Mini pole prism OR1PA : 2 to 300 m Compact prism CP series** : 2 to 600 m (2 to 1,000 m) Standard prism AP X 1 : 2 to 1600 m (2 to 4,000 m)
Minimum display:	Fine measurement : 1 mm (0.01 ft) Rapid measurement : 1 mm (0.01 ft)
Maximum slope distance:	9999.999 m (32808.33 ft)
Distance unit:	Meters / Feet (selectable)
Accuracy:	Fine measurement with white surface* : $\pm (5 + 3 \text{ ppm} \times D)$ mm with Reflective sheet RS90N : $\pm (3 + 3 \text{ ppm} \times D)$ mm with prism: $\pm (5 + 3 \text{ ppm} \times D)$ mm Rapid measurement with white surface* : $\pm (7 + 5 \text{ ppm} \times D)$ mm with Reflective sheet RS90N : $\pm (7 + 5 \text{ ppm} \times D)$ mm with prism: $\pm (7 + 5 \text{ ppm} \times D)$ mm
Measurement mode:	Fine measurement (single) /Rapid measurement (single)
Measuring time:	Fine measurement : 3.7 sec. Rapid measurement : 3.1 sec.
Signal source:	Laser diode
Wave length:	830nm
Atmospheric correction:	Temperature input range: - 30 to 60°C (in 1°C step) / -22 to 140°F Pressure input range: 500 to 1,400 hPa (in 1hPa step) 375 to 1,050 mmHg (in 1mmHg step) 14.8 to 41.3 inchHg (in 0.1 inchHg step) ppm input range: - 499 to 499 ppm (in 1 ppm step) Humidity input range: 0 to 100% (in 1% step)
Prism constant correction:	Constant input range: - 99 to 99 mm (in 1 mm step)
Earth curvature and refraction correction:	Atmospheric refraction constant No / Yes (K=0.14 or K=0.2 selectable)

* With white surface positioned at 90° to the SET and no reflecting sunlight.

** If measurement is more than 300 m, measuring range is affected by scintillation.

Power Supply

Power source: Ni-MH rechargeable battery BDC35 (6 V)
Working duration at 25°C: Distance & angle measurement (Fine & single measurement, interval = every 30 sec) : Approx. 5.5 hours
(approx. 660 points)
Angle measurement only : Approx. 7 hours

General

Display: 2LCD graphic displays on each face
120 dots X 64 dots (20 characters X 8 lines)
Keyboard: 28 keys
(numeric, edit, soft function, power on, light)
Sensitivity of levels: Plate level : 30"/2 mm
Circular level : 10"/2 mm
Optical plummet: Image: Erect
Magnification: 3X
Minimum focus: 0.5 m
Horizontal & Vertical motion screw : Fine/Coarse 2 speed
Automatic power cut off: Yes / No selectable
Calendar & Clock: Yes
Data storage: 448KB (about 3,000 points)
Data output: Asynchronous serial RS232C compatible
Centronics compatible (with DOC46)
Operating temperature: - 20 to 50°C
Instrument height: 236 mm (9.3 inch) from tribrach bottom
193 mm (7.6 inch) from tribrach dish
Size: 177 (W) X 165 (D) X 345 (H) mm (with handle and battery)
Weight: 5.4 kg (with handle and battery)

5. REGULATIONS

Radio Frequency Interference

WARNING: Changes or modifications to this unit not expressly approved by the party responsible for compliance could void the user's authority to operate the equipment.

NOTE: This equipment has been tested and found to comply with the limits for a Class A digital device pursuant to Part 15 of the FCC Rules. These limits are designed to provide reasonable protection against harmful interference when the equipment is operated in a commercial environment. This equipment generates, uses, and can radiate radio frequency energy and, if not installed and used in accordance with the instruction manual, may cause harmful interference to radio communications. Operation of this equipment in a residential area is likely to cause harmful interference in which case the user will be required to correct the interference at his own expense.

Notice for Canada

This Class A digital apparatus meets all requirements of Canadian Interference-Causing Equipment Regulations.

Cet appareil numérique de la Class A respecte toutes les exigences du Règlement sur le matériel brouilleur du Canada.

MEMO